

International  
Progress Report

**IPR-06-12**

# Äspö Hard Rock Laboratory

Status Report  
January– March 2006

Svensk Kärnbränslehantering AB

Juny 2006

***Svensk Kärnbränslehantering AB***

Swedish Nuclear Fuel  
and Waste Management Co  
Box 5864  
SE-102 40 Stockholm Sweden  
Tel 08-459 84 00  
+46 8 459 84 00  
Fax 08-661 57 19  
+46 8 661 57 19



**Äspö Hard Rock  
Laboratory**

Report no.  
**IPR-06-12**

Author  
**Kemakta**

Checked by

Approved  
**Anders Sjöland**

No.  
**F50K**

Date  
**Juny 2006**

Date

Date  
**2006-06-20**

# Äspö Hard Rock Laboratory

## Status Report January– March 2006

Svensk Kärnbränslehantering AB

Juny 2006

**Keywords:** Äspö HRL, Status Report

This report concerns a study which was conducted for SKB. The conclusions and viewpoints presented in the report are those of the author(s) and do not necessarily coincide with those of the client.

# Overview

The Äspö Hard Rock Laboratory (HRL) constitutes an important part of SKB's work to design and construct a geological repository for spent nuclear fuel and to develop and test methods for characterisation of a suitable site.

The plans for SKB's research and development of technique during the period 2005–2010 are presented in SKB's RD&D-Programme 2004 /SKB 2004/. The information given in the RD&D-Programme related to Äspö HRL is annually detailed in the Äspö HRL Planning Report /SKB 2006/.

This Äspö HRL Status Report is a collection of the main achievements obtained during the first quarter 2006.

## **Geoscience**

Geoscientific research is a natural part of the activities at Äspö HRL and is conducted in the fields of geology, hydrogeology, geochemistry (with emphasis on groundwater chemistry) and rock mechanics. The major aims are to establish and maintain geoscientific models of the Äspö HRL rock mass and to establish and develop the understanding of the Äspö HRL rock mass properties as well as the knowledge of applicable measurement methods. Studies are performed within the projects: Geological Mapping and Modelling, Method Development of a New Technique for Underground Surveying, Seismic Influence on the Groundwater System, Inflow Predictions, Hydro Monitoring Programme, Monitoring of Groundwater Chemistry, Rock Mechanics and Äspö Pillar Stability Experiment.

## **Buffer materials and backfill technology**

Before building a final repository, where the operating conditions include the deposition of one canister per day, further studies of the behaviour of the buffer and backfill under different installation conditions are required. SKB has decided to build a Bentonite Laboratory at Äspö designed for studies of buffer and backfill materials. The laboratory, a hall with dimensions 15×30 m, will include two stations where the emplacement of buffer material at full scale can be tested under different conditions. The hall will also be used for testing of different types of backfill material and the further development of techniques for the backfilling of deposition tunnels.

## **Natural barriers**

Many experiments in Äspö HRL are related to the rock, its properties and *in situ* environmental conditions. The goals are to increase the scientific knowledge of the safety margins of a final repository and to provide data for performance and safety assessment. The experiments performed at conditions expected to prevail at repository depth are: Tracer Retention Understanding Experiments (True Block Scale Continuation, True-1 Continuation and Completion), Long Term Diffusion Experiment, Colloid Project, Microbe Project, Matrix Fluid Chemistry Continuation and Radionuclide Retention Experiments.

Tests of models for groundwater flow, radionuclide migration and chemical/biological processes are one main purpose of the Äspö HRL. The major project is the Äspö Task Force on Modelling of Groundwater Flow and Transport of Solutes.

### ***Engineered barriers***

One of the goals for Äspö HRL is to demonstrate technology for and function of important parts of the repository system. This implies translation of current scientific knowledge and state-of-the-art technology into engineering practice applicable in a real repository. A number of large-scale field experiments are therefore conducted at Äspö HRL: Prototype Repository, Long Term Test of Buffer Material, Backfill and Plug Test, Canister Retrieval Test, Temperature Buffer Test, KBS-3 Method with Horizontal Emplacement, Large Scale Gas Injection Test, In Situ Corrosion Testing of Miniature Canisters, Cleaning and Sealing of Investigation Boreholes, Alternative Buffer Materials, Rock Shear Experiment and Earth Potentials. THM processes and gas migration in buffer material are addressed in the Task Force on Engineered Barrier Systems.

### ***Äspö facility***

Important parts of the Äspö facility are the administration, operation, and maintenance of instruments as well as development of investigation methods. The Public Relations and Visitor Services group is responsible for presenting information about SKB and its facilities e.g. the Äspö HRL. They arrange visits to the facilities all year around as well as special events.

### ***Environmental research***

On the initiative of the Äspö Environmental Research Foundation, the University of Kalmar has set up the Äspö Research School. The research school has a special interest in the transport of pollutants and their distribution in rock, groundwater and biosphere. The research school is co-financed by the municipality of Oskarshamn SKB, and the University of Kalmar.

### ***International co-operation***

The Äspö HRL has so far attracted considerable international interest. Nine organisations from eight countries participate in the co-operation or in Äspö HRL related activities, apart from SKB, during 2006.

# Contents

<b>1</b>	<b>General</b>	<b>5</b>
<b>2</b>	<b>Geoscience</b>	<b>6</b>
2.1	Geology	6
2.1.1	Geological Mapping and Modelling	6
2.1.2	RoCS – Method Development of a New Technique for Underground Surveying	7
2.2	Hydrogeology	8
2.2.1	Seismic Influence on the Groundwater System	8
2.2.2	Inflow Predictions	8
2.2.3	Hydro Monitoring Programme	10
2.3	Geochemistry	11
2.3.1	Monitoring of Groundwater Chemistry	11
2.4	Rock mechanics	11
2.4.1	Stress Measurements - Core Disking	11
2.4.2	Äspö Pillar Stability Experiment	12
<b>3</b>	<b>Buffer materials and backfill technology</b>	<b>13</b>
<b>4</b>	<b>Natural barriers</b>	<b>14</b>
4.1	Tracer Retention Understanding Experiments	15
4.1.1	True Block Scale Continuation	15
4.1.2	True-1 Continuation	16
4.1.3	True-1 Completion	16
4.2	Long Term Diffusion Experiment	18
4.3	Colloid Project	19
4.4	Microbe Project	20
4.5	Matrix Fluid Chemistry Continuation	21
4.6	Radionuclide Retention Experiments	22
4.7	Padamot	23
4.8	Fe-oxides in Fractures	24
4.9	Swiw-test with Synthetic Groundwater	25
4.10	Task Force on Modelling of Groundwater Flow and Transport of Solutes	25
<b>5</b>	<b>Engineered barriers</b>	<b>27</b>
5.1	Prototype Repository	28
5.2	Long Term Test of Buffer Material	29
5.3	Backfill and Plug Test	31
5.4	Canister Retrieval Test	32
5.5	Temperature Buffer Test	33
5.6	KBS-3 Method with Horizontal Emplacement	34
5.7	Large Scale Gas Injection Test	36
5.8	In Situ Corrosion Testing of Miniature Canisters	37
5.9	Cleaning and Sealing of Investigation Boreholes	38
5.10	Alternative Buffer Materials	39
5.11	Rock Shear Experiment	40

5.12 Earth Potentials	40
5.13 Task Force on Engineered Barrier Systems	41
<b>6 Äspö facility</b>	<b>42</b>
6.1 Facility Operation	42
6.2 Public Relations and Visitors Service	43
<b>7 Environmental research</b>	<b>44</b>
7.1 Äspö Research School	44
<b>8 International co-operation</b>	<b>45</b>
<b>9 Documentation</b>	<b>46</b>
9.1 Äspö International Progress Reports	46
9.2 Technical Documents and International Technical Documents	47
<b>10 References</b>	<b>48</b>

# 1 General

The Äspö Hard Rock Laboratory (HRL), in the Simpevarp area in the municipality of Oskarshamn, constitutes an important part of SKB's work with design and construction of a deep geological repository for final disposal of spent nuclear fuel.

One of the fundamental reasons behind SKB's decision to construct an underground laboratory was to create an opportunity for research, development and demonstration in a realistic and undisturbed rock environment down to repository depth. The underground part of the laboratory consists of a tunnel from the Simpevarp peninsula to the southern part of Äspö where the tunnel continues in a spiral down to a depth of 460 m. The rock volume and the available underground excavations have to be divided between all the experiments performed at the Äspö HRL. In Figure 1-1, the allocation of a selection of the experimental sites in Äspö HRL is shown.

The Äspö HRL and the associated research, development and demonstration tasks, managed by the Repository Technology Department within SKB, have so far attracted considerable international interest. During 2006, nine organisations from eight countries participate in the co-operation or in Äspö HRL-related activities.

SKB's overall plans for research, development and demonstration during the period 2005–2010 are presented in SKB's RD&D-Programme 2004 /SKB 2004/. The planned activities related to Äspö HRL are detailed on a yearly basis in the Äspö HRL Planning Report. The role of the Planning Report is also to present the background and objectives of each experiment and activity. This Status Report concentrates on the work in progress and refers to the Planning Report /SKB 2006/ for more background information. The Annual Report will in detail present and summarise new findings and results obtained during the present year.

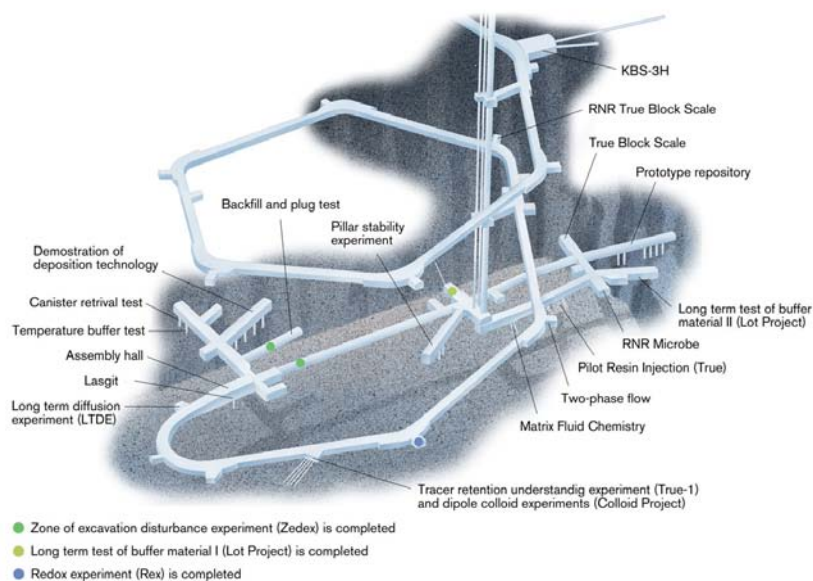

**Figure 1-1** Allocation of some of the experimental sites in Äspö HRL from -220 m to -450 m level.

## 2 Geoscience

Geoscientific research is a natural part of the activities at Äspö HRL and is conducted in the fields of geology, hydrogeology, geochemistry (with emphasis on groundwater chemistry) and rock mechanics. Studies are performed in laboratory and field experiments as well as by modelling work. The activities aim to provide geoscientific base data and to ensure high quality of experiments and measurements related to geosciences. The major aims can be summarised as:

- Establish and maintain geoscientific models of the Äspö HRL rock mass.
- Establish and develop the understanding of the Äspö HRL rock mass properties as well as the knowledge of applicable measurement methods.

### 2.1 Geology

#### 2.1.1 Geological Mapping and Modelling

---



All rock surfaces and drill cores at Äspö are mapped. This is done in order to increase the understanding of geometries and properties of rocks and structures, which is subsequently used as input in the 3D-modelling together with other input data.

Modelling tasks are performed both in the general geological 3D-model of the Äspö rock volume (the former GeoMod-project) and in more detailed scale on smaller rock volumes.

*Core dinking in TASQ-tunnel, bore hole KQ0062G01*

---

#### **Achievements**

At present all rock surfaces and drill cores from the Äspö rock volume are mapped. Some earlier mappings are, however, still not digitised and associated geological data not entered into the TMS-database (TMS – Tunnel Mapping System). A new computer for the TMS drawings and database has replaced the old one.

The drill cores from the ongoing core dinking project in the TASQ-tunnel, excavated for the Äspö Pillar Stability Experiment, have so far been only provisionally mapped. All data and drawings from the geological mappings performed in the tunnel that has been entered into the TMS, have been sent to SwedPower in Gothenburg to be included in an updated version of the geological model of TASQ-tunnel.

GeoVista AB has now completed the sampling in the TASA-tunnel. The sampling is a part of a project with the purpose to establish the true width of deformation zones by using magnetic anisotropy (AMS).



## 2.1.2 RoCS – Method Development of a New Technique for Underground Surveying

---



*Laser scanner combined with digital camera*

---

A feasibility study concerning geological mapping techniques is performed besides the regular mapping and modelling tasks. The project is conducted as an SKB-Posiva joint-project.

The major reasons for the RoCS project are aspects on objectivity of the data collected, traceability of the mappings performed, saving of time required for mapping and data treatment and precision in mapping, areas where the present mapping technique may not be adequate.

In this initial feasibility study-stage, the major objective is to establish a knowledge base concerning existing and possible future methods and techniques to be used for a mapping system suitable for SKB requirements.

### **Achievements**

The report concerning the RoCS feasibility study, phase 1 is almost completed. At this stage it appears as if laser scanning is to prefer to digital photogrammetry when it comes to collect geometric and geodetic data.

Due to the intention of widening a section in the TASQ-tunnel, excavated for the Äspö Pillar Stability Experiment, laser scanning combined with digital photography of the tunnel is planned. It will be performed in three stages, one before blasting and two after blasting of the part that will be widened. The first stage is already completed. The purpose of this scanning is to get the tunnel with its installations documented in 3D. The results can be used for e.g. calculations of rock volume, tunnel geometries and hopefully in the future for geological mapping. For personnel involved in RoCS the results are of great interest and possibly they are for people involved in e.g. design work too.

## 2.2 Hydrogeology

### 2.2.1 Seismic Influence on the Groundwater System

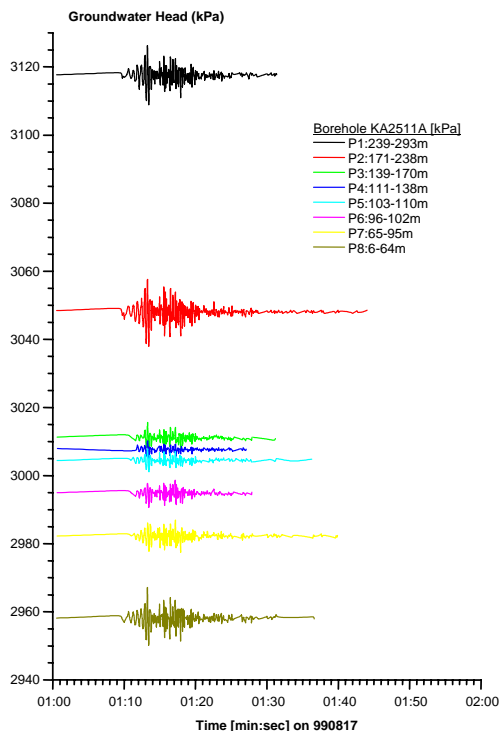

*Hydraulic response at Äspö HRL to the Kocaeli earthquake in Turkey*

The Hydro Monitoring System (HMS) registers at the moment the piezometric head in about 280 positions underground in the Äspö HRL.

An induced change of the head with more than 2 kPa triggers an intensive sampling. All measured data are stored in a database.

The data in the database are assumed to bear witness of different seismic activities in Sweden but also abroad, dependent on the magnitude of the event, as well as the position of the epicentre. The seismic events also include blasting activities in and around the Äspö HRL.

By analysing the data on changes in the piezometric head at Äspö, connections to specific seismic events are expected to be established. The work is a reference for the understanding of dynamic influences on the groundwater around a final repository.

### Achievements

Data are in the same way as earlier stored in HMS, waiting for future analyses. During the first quarter, the excavation of a new niche in the Q-tunnel gave the opportunity to study blasting effects on the piezometric head.

### 2.2.2 Inflow Predictions

SKB has conducted a number of large field tests where predictions of inflow into tunnels or depositions holes have been a component: Site characterisation and validation tests in Stripa, Prototype Repository and Groundwater degassing and two-phase flow experiments in Äspö HRL. The results from these tests show that when going from a borehole to a larger diameter hole, the inflow into the larger hole is often less than predicted, and the explanation for this is not yet well understood.

The ability to predict inflow is of importance from several aspects:

- Evaluation of experimental results from Äspö HRL. A good understanding of the mechanisms controlling inflow would improve the possibilities for good experimental set-ups and accurate result interpretation.

- Evaluation and comparisons between potential repository sites. It is desirable to be able to predict the inflow into the excavations, already before the construction work starts, based on hydraulic measurements made in small diameter boreholes.
- Evaluation of the expected bentonite buffer behaviour. The amount of inflow into deposition holes will influence the time needed for saturation and also the expected performance of the buffer.
- Design and optimisation of the repository layout. Poor prediction of inflow could lead to less optimal design alternatives.

### ***Achievements***

So far, extensive numerical analyses using the three-dimensional distinct element code 3DEC /Itasca 2003/ have been conducted. The aim has been to improve the knowledge about the effect of the effective stress redistribution, caused by excavation, on the fracture inflow into deposition holes considering single-phase flow /Mas Ivars 2004/. A report has been written about the hydro-mechanical data acquisition project at the Äspö pillar stability site /Mas Ivars 2005/. In this project a large field experiment was conducted with the aim of acquiring hydro-mechanical data during the drilling of the de-stressing slot at the pillar.

To better understand the data acquired, a three dimensional mechanical modelling study of the de-stressing of the APSE pillar has been carried out using 3DEC. The results from this modelling exercise show the stress redistribution in the tunnel during the drilling of the de-stressing slot. The report has been finalised and it is under revision for publishing.

For the next step, two 30 mm diameter boreholes have been drilled. These two boreholes intersected a very conductive fracture where flow and displacements were monitored during the de-stressing of the pillar. Coupled stress-flow laboratory tests have been conducted on large fracture samples from the mentioned boreholes. The surfaces of the fracture walls have been scanned using a 3D-laser scanner so the geometrical properties of the fracture plane can be well characterised. The results of the laboratory tests will be studied with the objective of improving already existing coupled hydro-mechanical fracture constitutive models so they can better represent the type of conductive fractures present at Äspö HRL.

### 2.2.3 Hydro Monitoring Programme

---

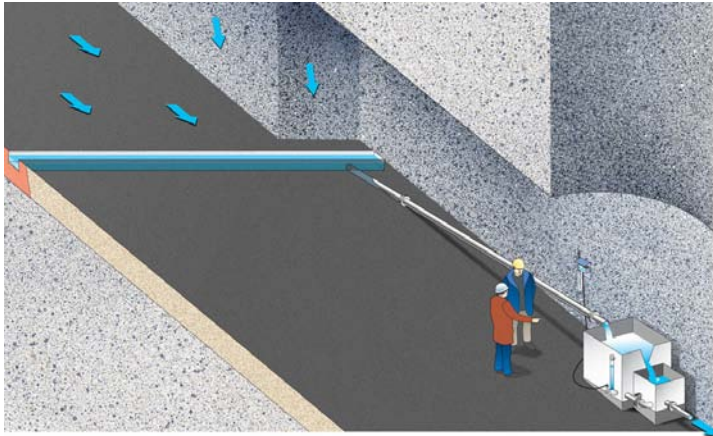

The monitoring of water level in surface boreholes started in 1987 while the tunnel excavation began to affect the groundwater level in many surface boreholes during the spring 1991. The computerised Hydro Monitoring System (HMS) implemented in the Äspö HRL and on the nearby islands was introduced in 1992. The HMS collects data on-line of pressure, levels, flow and electrical conductivity of the groundwater. Manual levelling is also obtained from the surface boreholes on a regular basis. The data are recorded by numerous transducers installed in boreholes, of which many are equipped with hydraulically inflatable packers, and in the tunnel. The number of boreholes included in the monitoring programme has gradually increased, and comprise boreholes in the tunnel in the Äspö HRL as well as surface boreholes on the islands of Äspö, Ävrö, Mjälén, Bockholmen and some boreholes on the mainland at Laxemar. Groundwater pressure or levels are measured by about 280 transducers. Water seeping through the tunnel walls is diverted to trenches and further to 25 weirs where the flow is measured. All data are transmitted to the main office at Äspö, by cable or radio.

Weekly quality checks of preliminary groundwater head data are performed. Absolute calibration of data is performed three to four times per year. This work involves comparison with groundwater levels checked manually in boreholes.

---

#### **Achievements**

The system has been performing well and the monitoring points from the previous year have been maintained. However, improvements are continuously made on the monitoring system to increase the performance. The system will continue to provide basic hydrogeological data and support the experiments undertaken. A report describing instrumentation, measurement methods and summarising the monitoring during 2004 is available /Nyberg *et al.* 2005/.

Quality check and calibration was made in December 2005 for data from the tunnel and in January for data from the surface boreholes.

## **2.3 Geochemistry**

### **2.3.1 Monitoring of Groundwater Chemistry**

During the Construction Phase of the Äspö HRL, different types of water samples were collected and analysed with the purpose of monitoring the groundwater chemistry and its evolution as the construction proceeded. At the beginning of the Operational Phase, sampling was replaced by a groundwater chemistry monitoring programme, aiming at a sufficient cover of the hydrogeochemical conditions with respect to time and space within the Äspö HRL. This programme is designed to provide information to determine where, within the rock mass, the hydrogeochemical changes are taking place and at what time stationary conditions are established.

#### ***Achievements***

The previous annual water sampling campaign was in the same way as earlier years scheduled to take place in September – October. Last year the sampling started the 31<sup>st</sup> August and was finalised in the middle of October. The results have been compiled in a chemistry report.

## **2.4 Rock mechanics**

Rock Mechanic studies are performed with the aims to increase the understanding of the mechanical properties of the rock but also to recommend methods for measurements and analyses. This is done by laboratory experiments and modelling at different scales and comprises:

- Natural conditions and dynamic processes in natural rock.
- Influences of mechanical, thermal and hydraulic processes in the near-field rock including effects of the backfill.

During 2006 work will be performed within the following projects:

- Coupled processes in rock including dynamic processes at natural conditions.
- Stress measurements and stress interpretation methods.
- Äspö Pillar Stability Experiment.

### **2.4.1 Stress Measurements - Core Disking**

The purpose of the project is to study the conditions under which core diskings occur by drilling in the vicinity of the area for the Äspö Pillar Stability Experiment.

A total of four holes were drilled vertically in the tunnel floor (KQ0062G05, KQ0062G06, KQ0061G10 and KQ0062G04). Core diskings in solid and hollow cores was observed in the first three of these. Two successful installations of the Borre probe used for stress measurements were made.

#### ***Achievements***

Most of the observed core diskings appears to be associated with discontinuities in the rock mass. One or several NW steeply dipping fractures intersect several of the

boreholes. Core dinking is many times associated to these structures, as well as induced in the location of probably sealed horizontal fractures. Stress measurements were made in two boreholes, however, only the results from one borehole may be reliable.

It was concluded that there is a need for an updated geological model over the fracturing in the investigated area to enable an interpretation of the results. The updated 3D model is expected to be available in May.

#### 2.4.2 Äspö Pillar Stability Experiment

---

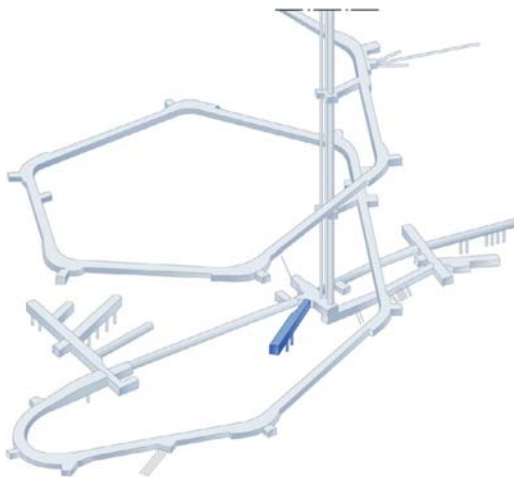

The major aims with the Pillar Stability Experiment are to demonstrate the capability to predict spalling in fractured rock mass and the effect of backfill on the propagation of micro cracks. The experiment is a complement to an earlier study performed at URL in Canada.

A new tunnel was excavated at Äspö HRL to ensure that the experiment was carried out in a rock mass with a virgin stress field. The site is located at the -450 m level. The pillar was created between two vertical deposition holes drilled in the floor of the tunnel.

The stress in the pillar was further increased by a thermal load to reach a stress state that induced brittle failure/spalling. One of the boreholes was subjected to an internal water pressure via a rubber bladder giving a confining pressure of 0.7 MPa.

The heating phase of the experiment was finished in mid July 2004. Spalling occurred to almost five metres depth in the open borehole and good measuring series were achieved with all the instruments used. Five pillar blocks were sawn and in January 2005 all blocks were lifted up.

---

#### **Achievements**

Draft journal papers describing the design of the experiment and the determination of the spalling strength of the pillar has been written and will be submitted for review in August. A conference paper describing the thermal back calculation has been presented at the GeoProc 2006 conference in Nanjing, China.

The reporting of the detailed geological mapping of the pillar is almost finished and will be published as an International Progress Report (IPR). The results from the mapping have been used to produce a 3D model of the pillar geology in Surpac Surveying Software. The model also includes acoustic events from the experiment. The model enhances the understanding of the geology in the pillar.

### 3 Buffer materials and backfill technology

Before building a final repository, where the operating conditions include the deposition of one canister per day, further studies of the behaviour of the buffer and backfill under different installation conditions are required. SKB has decided to build a Bentonite Laboratory at Äspö designed for studies of buffer and backfill materials. The laboratory, a hall with dimensions 15×30 m, will include two stations where the emplacement of buffer material at full scale can be tested under different conditions. The hall will also be used for testing of different types of backfill material and the further development of techniques for the backfilling of deposition tunnels.

#### ***Achievements***

An application for a building permit was compiled and sent to the local building board in January 2006. Somewhat later the application was granted by the local building board without stating any special conditions to be considered when constructing the new Bentonite Laboratory. A glance on some information on the valid facade drawing are presented in Figure 3-1. The facades of the Bentonite Laboratory will be painted in red to coincide with the existing buildings at Äspö.

Currently the purchasing phase is ongoing and a contractor is planned to be engaged before the end of April this year. If this plan will come true it should be possible to have the new laboratory ready for occupation in the late fall 2006.

Furthermore, as planned, two project leaders and one industry-funded PhD student have been recruited to the group Technology and Science at Äspö HRL. The whole body of the three new employees will be engaged in new experiment to be accomplished in the Bentonite Laboratory. The two project leaders have already been engaged in subprojects within the SKB project BACLO (Backfilling and Closure of the Deep Repository) Phase III. When waiting for the facilities in the new Bentonite Laboratory some initial experiments/studies will be carried out in temporarily halls and in the tunnel TASO at the level -220 m, i.e. in the tunnel close to the Canister Retrieval Test in the Äspö HRL.

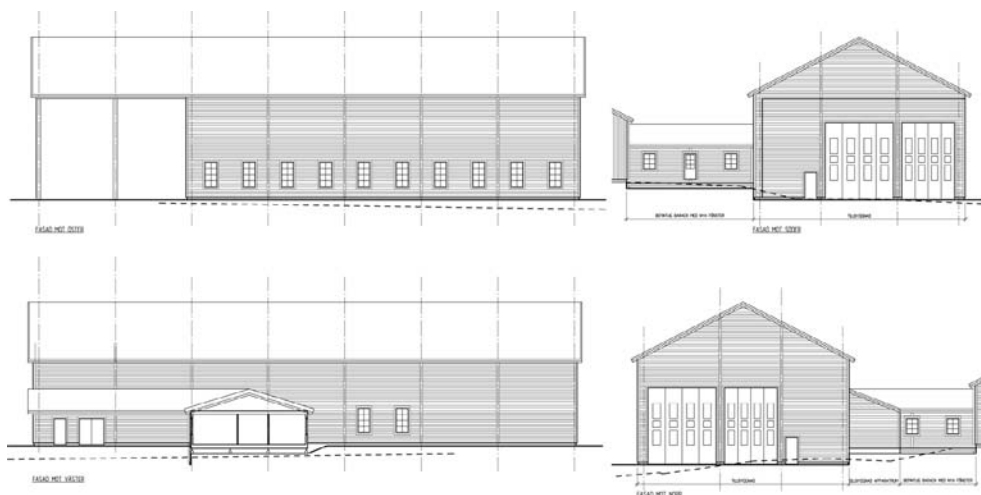
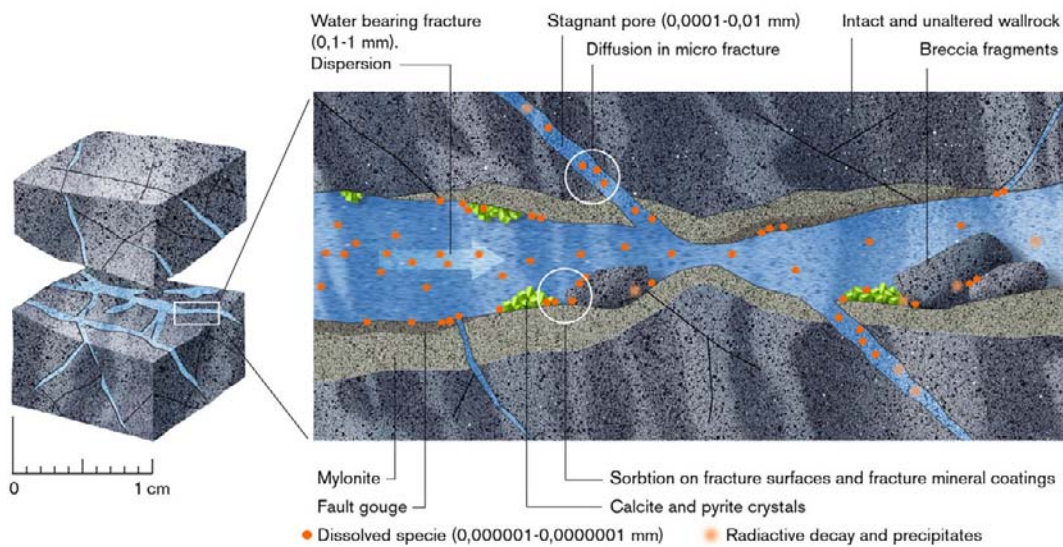

***Figure 3-1*** Facade drawing of the new Bentonite Laboratory

## 4 Natural barriers

At the Äspö HRL, experiments are performed at conditions that are expected to prevail at repository depth. The experiments are related to the rock, its properties, and *in situ* environmental conditions. The goals are to increase the scientific knowledge of the safety margins of the repository and to provide data for performance and safety assessment and thereby clearly present the role of the geosphere for the barrier functions: isolation, retardation and dilution. As an example, the processes that influence migration of species along a natural rock fracture are shown in Figure 4-1.

Tests of models for groundwater flow, radionuclide migration and chemical/biological processes are one of the main purposes of the Äspö HRL. The programme includes projects with the aim to evaluate the usefulness and reliability of different models and to develop and test methods for determination of parameters required as input to the models.

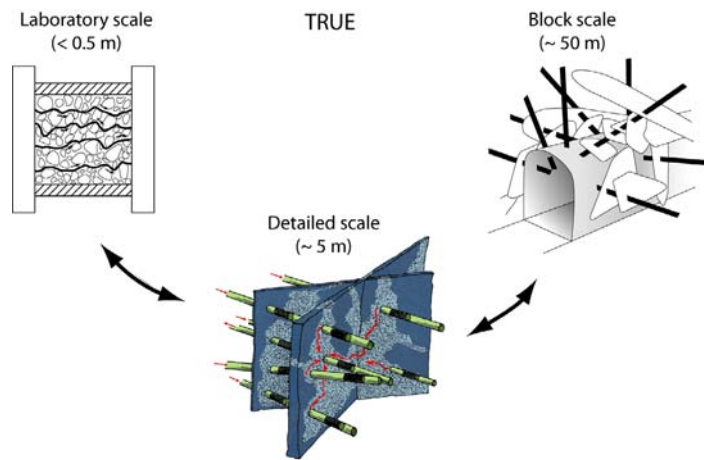

**Figure 4-1** Processes that influence migration of species along a natural rock fracture.



## 4.1 Tracer Retention Understanding Experiments

---



Tracer tests with non-sorbing and sorbing tracers are carried out in the True family of projects. These are conducted at different scales; laboratory scale (< 0.5 m), detailed scale (<10 m) and block scale (up to 100 m) with the aim to improve understanding of transport and retention in fractured rock. The work includes building of hydrostructural models and conceptual microstructure models. Numerical models are used to assess the relative contribution of flow-field related effects and acting processes (diffusion and sorption) on *in situ* retention.

The first *in situ* experiment (True-1) performed in the detailed scale and the True Block Scale series of experiments have come to their respective conclusion.

Complementary field work and modelling are currently performed as part of two separate but closely coordinated continuation projects. The True Block Scale Continuation project aims at obtaining additional understanding of the True Block Scale site. In the True-1 Continuation and Completion projects the objectives are to obtain insight in the internal structure of the investigated feature and to study fixation of sorbing radioactive tracers. Prior to the resin injection in Feature A complementary hydraulic and tracer tests are performed to better understand Feature A and its relation to the surrounding fracture network. In addition, a dress rehearsal of *in situ* resin injection is realised through a characterisation project focused on fault rock zones.

---

### 4.1.1 True Block Scale Continuation

The True Block Scale Continuation (BS2) project has its main focus on the existing True Block Scale site. The True Block Scale Continuation is divided into two separate phases:

- BS2a Complementary modelling work in support of BS2 *in situ* tests. Continuation of the True Block Scale (phase C) pumping and sampling including employment of developed enrichment techniques to lower detection limits.
- BS2b Additional *in situ* tracer tests based on the outcome of the BS2a analysis. *In situ* tests are preceded by reassessment of the need to optimise/remediate the piezometer array.

In the aftermath to the BS2 project a discussion has been in process to set up a second step of continuation of the True Block Scale (BS3). This step would not have specific experimental components, but rather emphasise consolidation and integrated evaluation of all relevant True data and findings collected thus far. This integration would not necessarily be restricted to True Block Scale, but could also include incorporation of True-1 and True-1 Continuation results.

## **Achievements**

Remaining contributions to the final report (BS2a and BS2b) are received and edition work is initiated. During this quarter only minor work has been done due to heavy engagement of SKB consultants in the ongoing site investigations and modelling.

### **4.1.2 True-1 Continuation**

The True-1 Continuation project is a continuation of the True-1 experiments and the experimental focus is primarily on the True-1 site. The continuation includes performance of the planned injection of epoxy resin in Feature A at the True-1 site and subsequent overcoring and analysis (True-1 Completion, see below). In addition, this project includes production of a series of scientific articles based on the True-1 project and, furthermore, performance of the Fault Rock Characterisation project, the latter in parts a dress rehearsal for True-1 Completion.

## **Achievements**

True-1 Continuation achievements include:

- Two of the three scientific papers on the True team analysis of the True-1 experiments now available in draft:  
Part 1) Experimental results, conceptual model and effective parameter estimation  
Part 2) Micro-scale characterisation retention parameters
- The papers (final drafts) are currently subject to internal project review before being submitted to the editor of WRR.
- The principal achievements of the True-1 Completion subproject are accounted for below in Section 4.1.3.
- No work has been performed within the Fault Rock Zones Characterisation subproject.

### **4.1.3 True-1 Completion**

The True-1 Completion project, with epoxy injection and subsequent over-coring of Feature A at the True-1 site as the main activity, has been initiated.

True-1 Completion is a sub-project of the True-1 Continuation project with the experimental focus placed on the True-1 site. True-1 Completion will be performed at the True-1 site and will be a complement to already performed and ongoing projects. The main activity within True-1 Completion is the injection of epoxy with subsequent over-coring of the fracture and following analyses of pore structure and, if possible, identification of sorption sites. Furthermore, several complementary *in situ* experiments will be performed prior to the epoxy injection. These tests are aimed to secure important information from Feature A and the True-1 site before the destruction of the site, the latter which is the utter consequence of True-1 Completion.

### ***Achievements***

The complementary tracer tests have been initiated by the performance of SWIW pre-tests. The aim of the pre-tests are to verify if SWIW tests with radioactive tracers can be performed at the True-1 site without the risk of losing tracer in the rock. The pre-test will also provide vital information on the tracer distribution around the SWIW borehole. Preliminary results show a very low recovery of the injected tracer, the consequence being that SWIW tests with radioactive tracers cannot be performed.

Planning and preparation for the cation exchange test is ongoing.

## 4.2 Long Term Diffusion Experiment

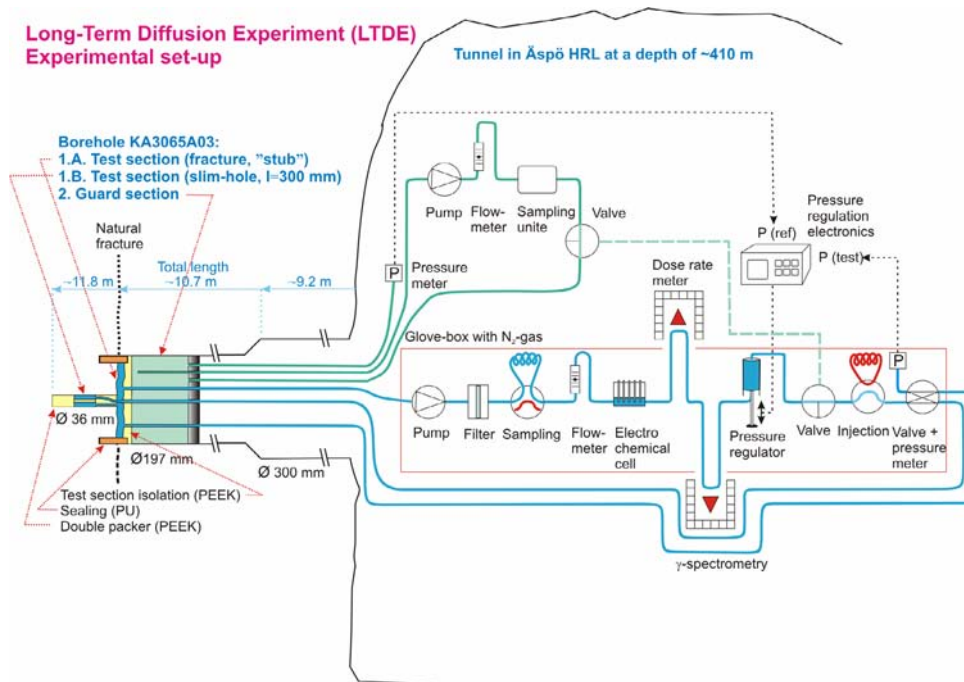

This experiment is performed to investigate diffusion and sorption of solutes in the vicinity of a natural fracture into the matrix rock and directly from a borehole into the matrix rock.

The aims are to improve the understanding of diffusion and sorption processes and to obtain diffusion and sorption data at *in situ* conditions.

A core stub with a natural fracture surface is isolated in the bottom of a large diameter telescoped borehole and a small-diameter borehole is drilled through the core stub and beyond into the intact unaltered bedrock. Tracers will be circulated over a period of 5-7 months after which the borehole is over-cored and analysed for tracer content.

### **Achievements**

The performed functionality test with short lived radionuclides during autumn 2005 is compiled and the report is being reviewed. The report on the performed hydrogeological pre-test programme is also compiled and in review.

Complementary measures on test equipment have been carried out and are ongoing to prepare the test equipment for the forthcoming LTDE main sorption diffusion test.

Since the original project plan was laid out by Byegård *et al.* /1999/ the experimental concept has been modified with complementary addition of a small diameter borehole, enabling study of sorption and diffusion both at a natural fracture surface and onto matrix rock. A new project plan has been compiled which to a large extent is an updated and modified version of the original project plan from 1999, considering both the addition of the small diameter borehole to the experimental set-up, the present focus on sorption processes, and the shorter experimental time frame (5-7 months) for *in situ* sorption-diffusion. The changed focus is pointed out by renaming the project LTDE-SD, adding acronyms for Sorption and Diffusion.

## 4.3 Colloid Project

### *Borehole specific measurements*

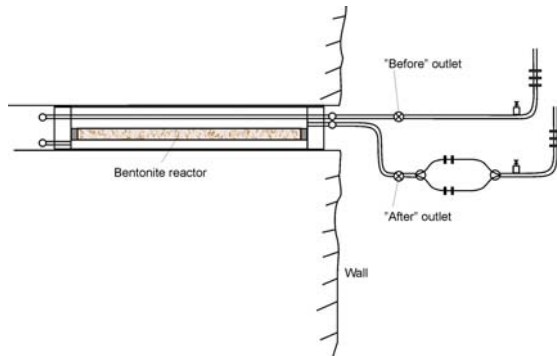

### *Colloid dipole experiment*

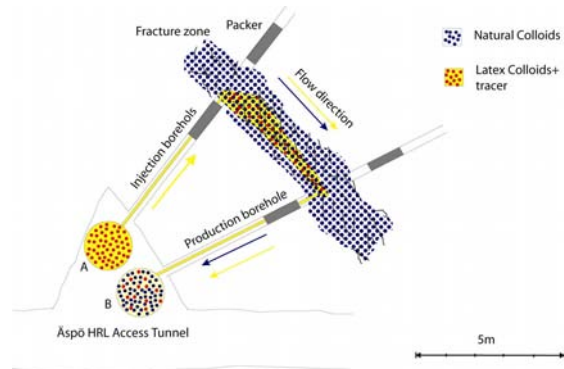

In the Colloid Project the concentration, stability and mobility of colloids in the Äspö environment are studied. The project comprises studies of the potential of colloids to enhance solute transport and the potential of bentonite clay as a source for colloid generation. The Colloid Project includes laboratory experiments, background colloid measurements, borehole specific measurements, colloid dipole experiments and *in situ* experiments where the colloidal effect on actinide transport in a water bearing fracture will be studied.

### **Achievements**

There are ongoing experiments on bentonite colloid migration in a water bearing fracture which is performed by Peter Vilks, AECL. Preliminary results indicate that bentonite colloids in diluted water filtrate, so that the smaller colloids in the size distribution are mobile, while the larger ones are trapped in the fracture. Bentonite and latex colloids behave in a similar way in the experiments with high pump flows. The experiments with lower pump flows are not yet completed.

Migration experiments with latex colloids in Feature A at True-1 are completed but yet not evaluated. Preliminary results show breakthrough of latex colloids with mean sizes of 50 and 100 nm, but they are delayed compared to the reference conservative tracer uranine.

The effect of Ca and Na on bentonite colloids stability has been tested in the laboratory. The cation exchange capacity (CEC-value) for Ca and Na will be evaluated from the laboratory tests.

## 4.4 Microbe Project

---



The Microbe Project has been initiated in the Äspö HRL for studies of the microbial activity in groundwater at *in situ* conditions. The major objectives are to:

- Offer proper circumstances for research on the effect of microbial activity on the long-term chemical stability of the repository environment.
- Provide *in situ* conditions for the study of bio-mobilisation of radionuclides.
- Present a range of conditions relevant for the study of bio-immobilisation of radionuclides.
- Enable investigations of bio-corrosion of copper under conditions relevant for a high level radioactive waste repository.
- Constitute a reference site for testing and development of methods used in the site investigations.

The main Microbe site is on the -450 m level where a laboratory container with benches, an anaerobic gas box and an advanced climate control system is located. Three core drilled holes, KJ0050F01, KJ0052F01 and KJ0052F03, intersecting water conducting fractures are connected to the Microbe laboratory via tubings. Each borehole has been equipped with a circulation system offering 2112 cm<sup>2</sup> of test surface.

Retention of naturally occurring trace elements in the groundwater by Biological Iron Oxides (Bios) is investigated at a site at tunnel length 2200 m. There is a vault with a borehole that delivers groundwater rich in ferrous iron and iron oxidising bacteria. The borehole is connected to two 200 x 30 x 20 cm artificial channels that mimic ditches in the tunnel. The channels have rock and artificial plastic support that stimulate Bios formation.

---

### **Achievements**

The effect from disturbance from other experiments at Äspö has been reported /Pedersen 2005/. New and stable groundwater conditions were reached in January. New groundwater analyses of chemistry (Class V) have been initiated. The Microbe container and its equipment have been attached to the logging system at Äspö. Data on pressures, temperature and flow are collected at hourly intervals. Experiments aiming at the understanding of the hydrogen-acetate pathway and its relation to the redox potential were started last week in March.

## 4.5 Matrix Fluid Chemistry Continuation

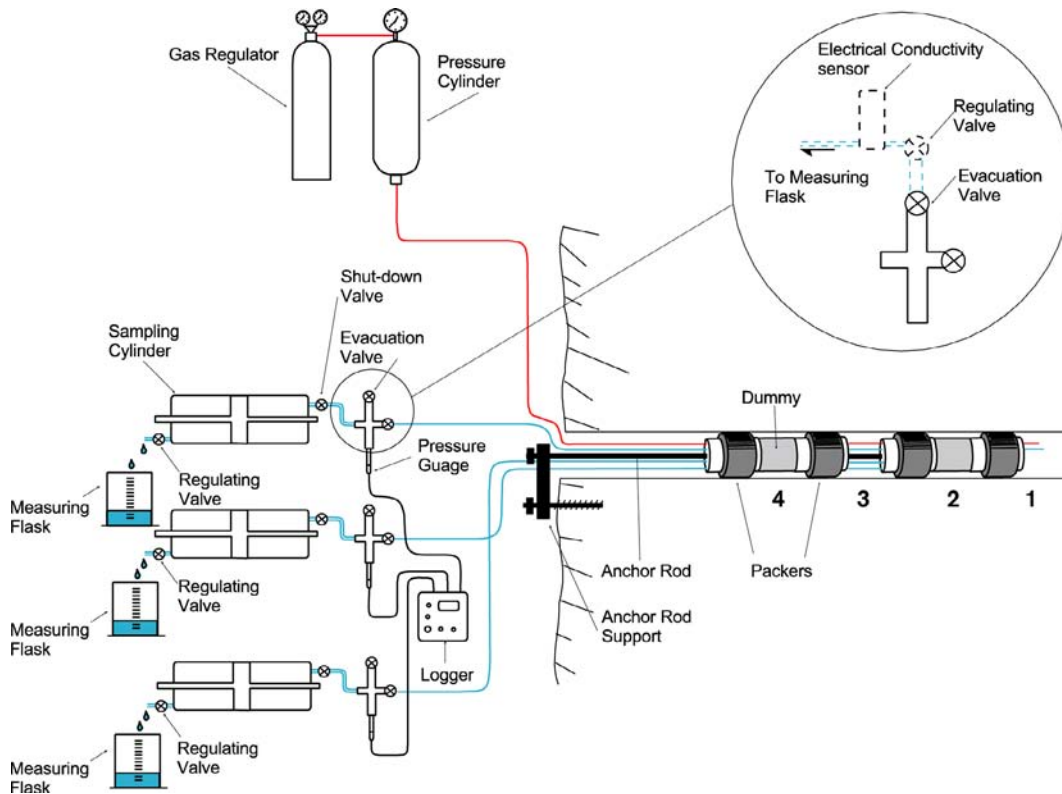

The main objectives of the Matrix Fluid Chemistry experiment are to understand the origin and age of fluids/groundwaters in the rock matrix pore space and in micro-fractures, and their possible influence on the chemistry of the groundwaters from the more highly permeable bedrock.

Matrix fluids are sampled from a borehole drilled into the rock matrix. Fluid inclusions in core samples have also been studied to determine their

contribution, if any, to the composition of the matrix fluids/groundwaters.

A first phase of the project is finalised and reported /Smellie *et al.* 2003/. The major conclusion is that pore water can successfully be sampled from the rock matrix and there is no major difference in chemistry compared to groundwaters from more highly conductive fracture zones in the near-vicinity.

### **Achievements**

The borehole equipment, modified to conduct the hydraulic tests, was reinstalled on November 29<sup>th</sup>, 2005. However, the pressure response when using a water injection pressure of 10 bar was not as expected and the test was terminated on December 9<sup>th</sup>.

During the first quarter the project has proceeded as follows:

- The subsequent change in pressure monitored by the HMS was not as expected and it was decided on January 4<sup>th</sup>, 2006 to remove the borehole equipment to ascertain the problem.
- After some adjustments the equipment was tested satisfactorily on 19-20<sup>th</sup> January, refilled with distilled water and reinstalled.

- The pressure response this time was closer to what was expected and the hydraulic injection testing programme was restarted.
- The hydraulic testing programme is on-going.
- Porosity measurements on drillcore material to supplement data from the Matrix Fluid Chemistry Experiment have been carried out successfully. The report has been completed, reviewed and submitted for publication as a technical document. In parallel, a version has been submitted to Engineering Geology and subsequently accepted and published /Tullborg and Larson 2006/.

## 4.6 Radionuclide Retention Experiments

---

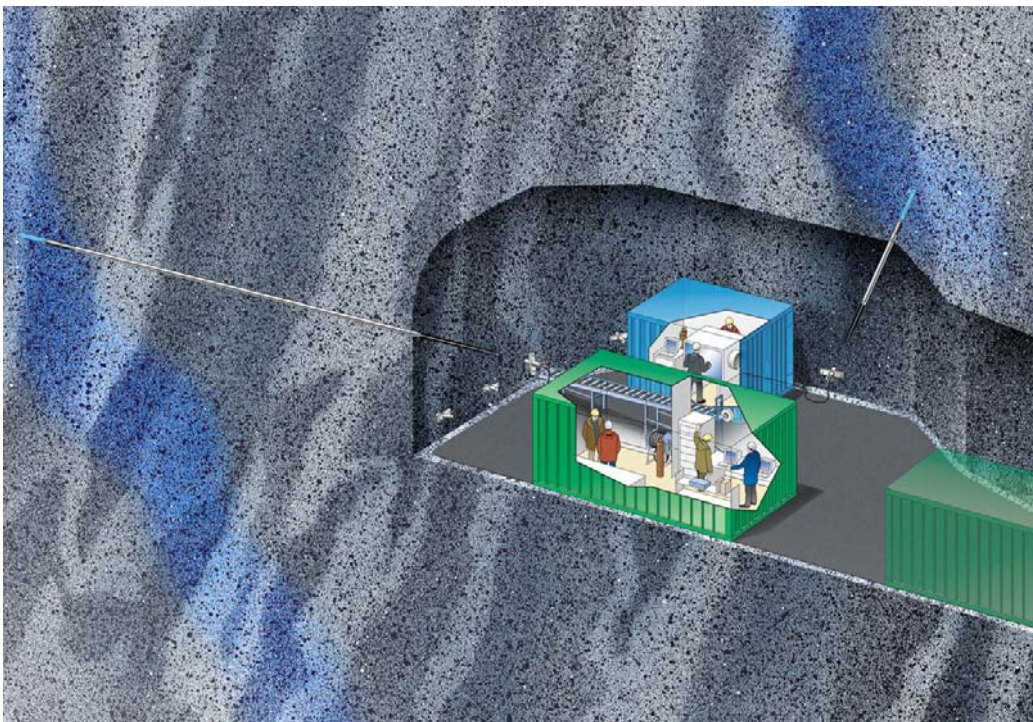

Radionuclide Retention Experiments are carried out with the aim to confirm results of laboratory studies *in situ*, where natural conditions prevail concerning e.g. redox conditions, contents of colloids, organic matter and bacteria in the groundwater.

The experiments are carried out in special borehole laboratories, Chemlab 1 and Chemlab 2, designed for different kinds of *in situ* experiments. The laboratories are installed in boreholes and experiments can be carried out on bentonite samples and on tiny rock fractures in drill cores.

### Chemlab 1:

- Investigations of the influence of radiolysis products on the migration of the redox-sensitive element technetium in bentonite (finalised).
- Investigations of the transport resistance at the buffer/rock interface (planned).

### Chemlab 2:

- Migration experiments with actinides in a rock fracture (almost finalised).
- Study leaching of spent fuel at repository conditions (planned).

---

## Achievements

The results from the final field experiment on actinide migration has been evaluated and reported by Forschungszentrum Karlsruhe (FZKA). The final report will be based on this and five earlier FZKA-reports.



## 4.7 Padamot

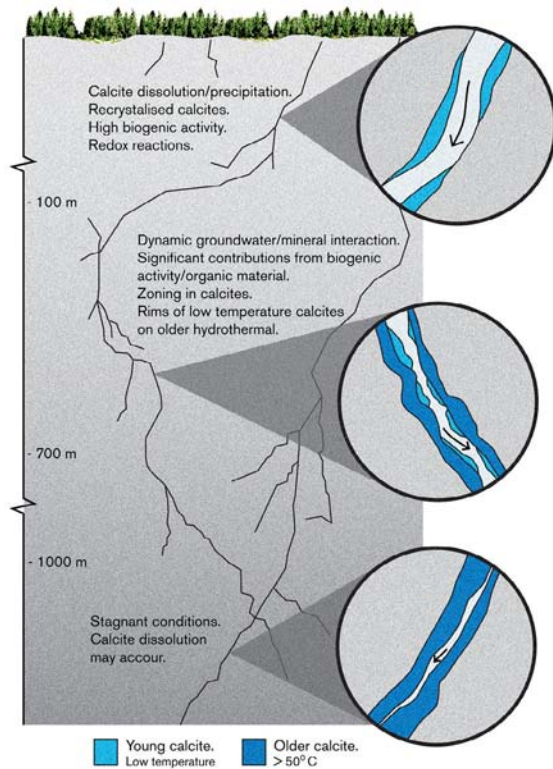

*Potential calcite-groundwater interaction at various depths at Äspö.*

Padamot (Palaeohydrogeological Data Analysis and Model Testing) investigates changes in groundwater conditions as a result of changing climate. Because the long term safety of an underground repository depends on the stability of the repository environment, demonstration that climatic impacts attenuate with depth is important. Currently, scenarios for groundwater evolution relating to climate changes are poorly constrained by data and process understanding.

The objectives of Padamot are to:

- Improve understanding and prioritise palaeohydrogeological information for use in safety assessments.
- Collect chemical/isotopic data using advanced analytical methods.
- Construct a database of relevant information and develop numerical models to test hypotheses.
- Integrate and synthesise results to constrain scenarios used in performance assessments.
- Disseminate the results to the scientific community.

The EC-part of the project was finalised and reported in 2005. The present project comprises analytical and modelling tasks. Deep borehole cores from rocks at the Äspö HRL and Laxemar (KXL01) are used in the analytical study.

### **Achievements**

The experiences concerning methodology for palaeohydrogeological studies based on fracture mineralogy and geochemistry from the Padamot and former Equip projects are used within the SKB site investigations. A paper describing the methodology is presently being prepared.

## 4.8 Fe-oxides in Fractures

---

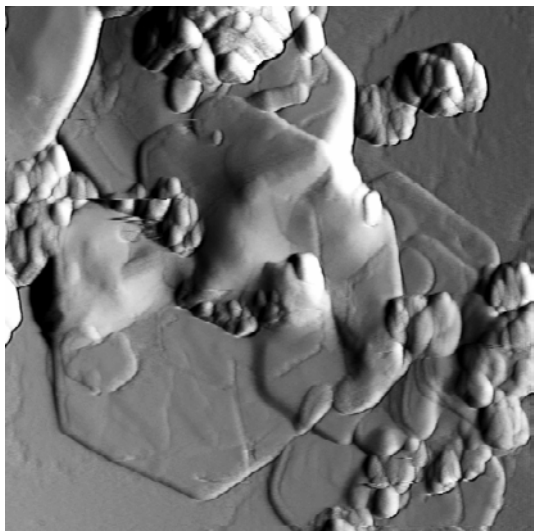

*Atomic Force Microscopy image of green rust sulphate. Image is 2.5 x 2.5 microns*

Proof of reducing conditions at repository depth is fundamental for the safety assessment of radioactive waste disposals. Fe(II) - minerals are common in the bedrock and along fracture pathways and constitute a considerable reducing capacity together with organic processes. Another area of interest is the radionuclide retention capacity provided by Fe-oxides and -oxyhydroxides in terms of sorption capacity and immobilisation.

The basic idea of the project is to examine Fe-oxide fracture linings, in order to explore for suitable palaeo-indicators for their formation conditions, while at the same time learning about the behaviour of trace component uptake in general, both from the natural material as well as through testing of behaviour in controlled parametric studies in the laboratory.

---

### **Achievements**

During the last quarter most emphasis has been on reporting and publication. Two papers have been submitted to scientific journals for publication and two reports will be published in the Äspö International Progress Report series, see Table 4-1.

Future plans were discussed at a meeting held in Copenhagen on March 3<sup>rd</sup>. A continuation project proposal with the title “To Establish the Penetration Depth of Oxidising Waters below Ground” was submitted to SKB in March 2006.

---

#### **Table 4-1 Reporting in progress**

##### **Scientific papers for publication in *Geochimica et Cosmochimica Acta***

Skovbjerg L, Stipp S, Utsunomiya S, Ewing R, 2006. The mechanisms of reduction of hexavalent chromium by green rust sodium sulphate: Formation of Cr-goethite (Resubmitted in February 2006)

Dideriksen K, Christiansen B, Baker J, Frandsen C, Balic-Zunic T, Tullborg E, Mørup S, Stipp S, 2006. Fe-oxide fracture-fillings as a palaeo-temperature and redox indicator: Structure, crystal form, REE content and Fe isotope composition (Submitted March 2006).

##### **Reports for publication in the Äspö International Progress Report series**

Dideriksen K, Stipp S, 2006. Iron Oxides in Fractures at Äspö. A feasibility study to test the possibility of finding a geothermometer or a palaeo-redox indicator. (Submitted).

Dideriksen, K., Christiansen, B., Skovbjerg, L., Sonne, L., Hansson, E., Stipp, S. and Tullborg, E-L. (2006). Fe-oxide Report: Progress to the end of 2004: Scope, Results and Perspectives (May 2005)

---

## 4.9 Swiw-test with Synthetic Groundwater

The Project *Swiw-test with Synthetic Groundwater* constitutes a complement to performed tests and studies on the processes governing retention, e.g. the True-1 and the True Block Scale experiments. This project aims to deepen the understanding for the processes governing retention. Swiw-tests (single well injection withdrawal) with synthetic groundwater facilitate the study of diffusion in stagnant water zones and in the rock matrix. It also facilitates the possibility to test the concept of measuring fracture aperture with the radon concept.

The location for the tests will be the True Block Scale site and the well characterised Structures #19 and #20. The two structures, have been object to a large number of tracer tests, possess different characteristics and are located on different distances from the tunnel. The revisit of the True Block Scale site facilitates the unique possibility to "calibrate" the concept of single hole tracer tests, Swiw, to multiple borehole tracer tests. The results from such a calibration can be applied directly to the Swiw-tests performed within the SKB site investigation programme.

### **Achievements**

The main part of 2006 will be devoted to a feasibility study, determination of scope and planning of the work ahead.

## 4.10 Task Force on Modelling of Groundwater Flow and Transport of Solutes

---

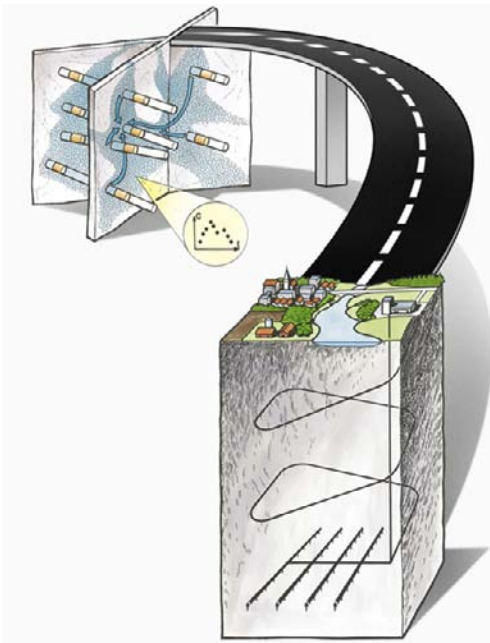

The Äspö Task Force on Modelling of Groundwater Flow and Transport of Solutes is a forum for the organisations supporting the Äspö HRL to interact in the area of conceptual and numerical modelling of groundwater flow and transport of solutes in fractured rock.

The Task Force shall propose, review, evaluate and contribute to the modelling work in the project. In addition, the Task Force shall interact with the principal investigators responsible for carrying out experimental and modelling works for Äspö HRL.

The work within the Äspö Task Force constitutes an important part of the international co-operation within the Äspö Hard Rock Laboratory.

---

## **Achievements**

In the Task Force, work has been in progress in Task 6 – Performance Assessment Modelling Using Site Characterisation Data, and in Task 7, which addresses a long-term pumping test in Olkiluoto, Finland. The status of the specific modelling tasks is given within brackets in Table 4-2. The 21<sup>st</sup> Task Force meeting was hosted by Andra in Paris on 6-9<sup>th</sup> March.

Task 6 tries to bridge the gap between Performance Assessment (PA) and Site Characterisation (SC) models by applying both approaches for the same tracer experiment. It is hoped that this will help to identify the relevant conceptualisations (in processes/structures) for long term PA predictions and identify site characterisation data requirements to support PA calculations. The review report for Tasks 6 A, B and B2 has been printed /Hodgkinson and Black 2005/. Also, the review report for Task 6C has been printed /Black and Hodgkinson 2005/. It has been decided that Tasks 6 D, E, F and F2 are to be reported together, and the work with this combined report is in progress. The review report for Task 6 D, E and F is available as a draft. A summary of the outcome of Task 6 will be published in a scientific paper. In addition, some modelling groups have indicated interest in publishing papers in the same scientific journal, and in conjunction with the summary paper. The 21<sup>st</sup> Task Force meeting was in a way the grand final for Task 6.

Task 7 addresses modelling of the KR24 long-term pumping test at Olkiluoto in Finland. The task will focus on methods to quantify uncertainties in PA-type approaches based on SC-type information; along with being an opportunity to increase the understanding of the role of fracture zones as boundary conditions for the fracture network and how compartmentalisation affect the groundwater system. The possibilities to extract more information from interference tests will also be addressed. A task description for the sub-task 7A has been sent out to the modellers and preliminary results from the modelling were presented at the 21<sup>st</sup> Task Force meeting in Paris, March 2006.

**Table 4-2 Task descriptions and status of the specific modelling sub-tasks.**

---

6A	Model and reproduce selected True-1 tests with a PA model and/or a SC model to provide a common reference. (External review report printed).
6B	Model selected PA cases at the True-1 site with new PA relevant (long term/base case) boundary conditions and temporal scales. This task serves as means to understand the differences between the use of SC-type and PA-type models and the influence of various assumptions made for PA calculations for extrapolation in time. (External review report printed).
6C	Develop semi-synthetic, fractured granite hydrostructural models. Two scales are supported (200 m block scale and 2000 m site-scale). The models are developed based on data from the Prototype Repository, True Block Scale, True-1 and Fracture Characterisation and Classification project (FCC). (External review report printed).
6D	This sub-task is similar to sub-task 6A and is using the synthetic structural model in addition to a 50 to 100 m scale True-Block Scale tracer experiment. (Draft reports available and review in progress).
6E	This sub-task extends the sub-task 6D transport calculations to a reference set of PA time scales and boundary conditions. (Draft reports available and review in progress).
6F	Task 6F is a sensitivity study, which is proposed to address simple test cases, individual tasks to explore processes and to test model functionality. (Draft reports available and review in progress).
7	Long-term pumping experiment. (Preliminary results presented at TF#21).

---

## 5 Engineered barriers

One of the goals for Äspö HRL is to demonstrate technology for and function of important parts of the repository system. This implies translation of current scientific knowledge and state-of-the-art technology into engineering practice applicable in a real repository.

It is important that development, testing and demonstration of methods and procedures, as well as testing and demonstration of repository system performance, are conducted under realistic conditions and at appropriate scale. A number of large-scale field experiments and supporting activities are therefore conducted at Äspö HRL, see Figure 5-1. The experiments focus on different aspects of engineering technology and performance testing and will together form a major experimental programme.

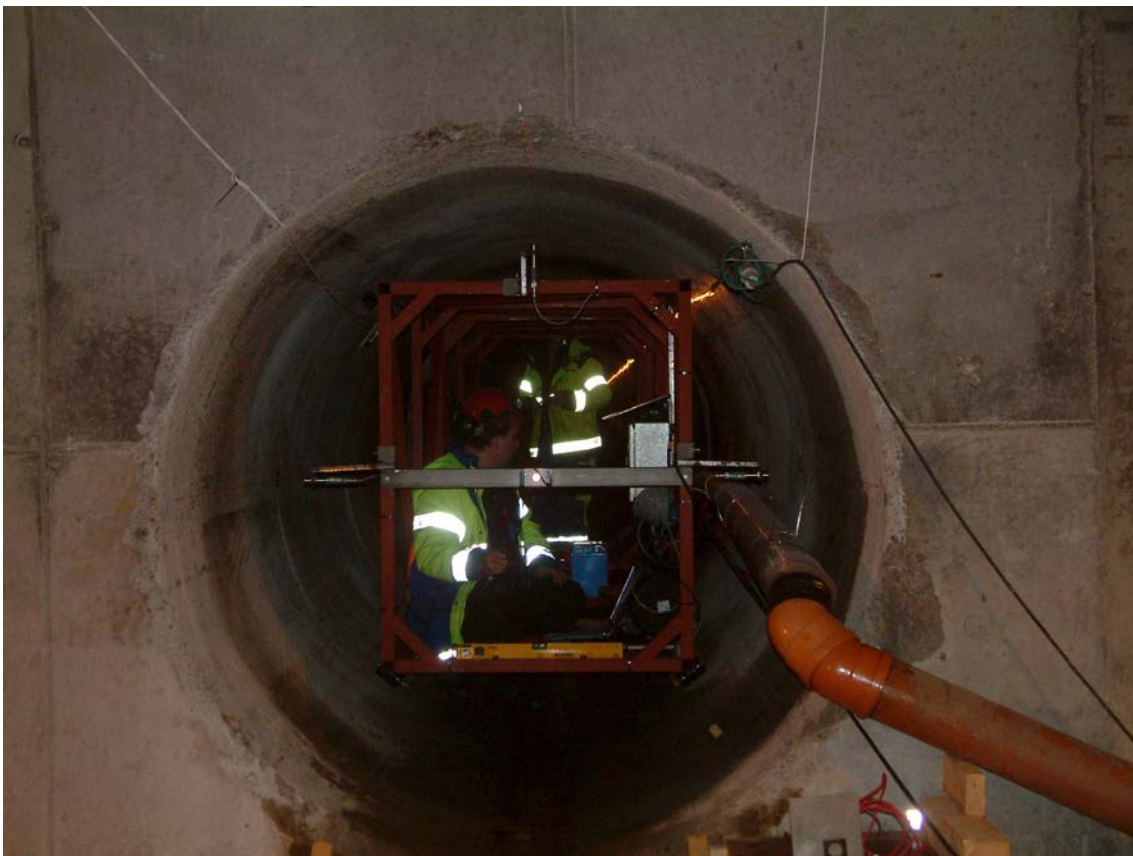

*Figure 5-1 Control measurements of horizontal deposition hole (KBS-3H).*

## 5.1 Prototype Repository

---

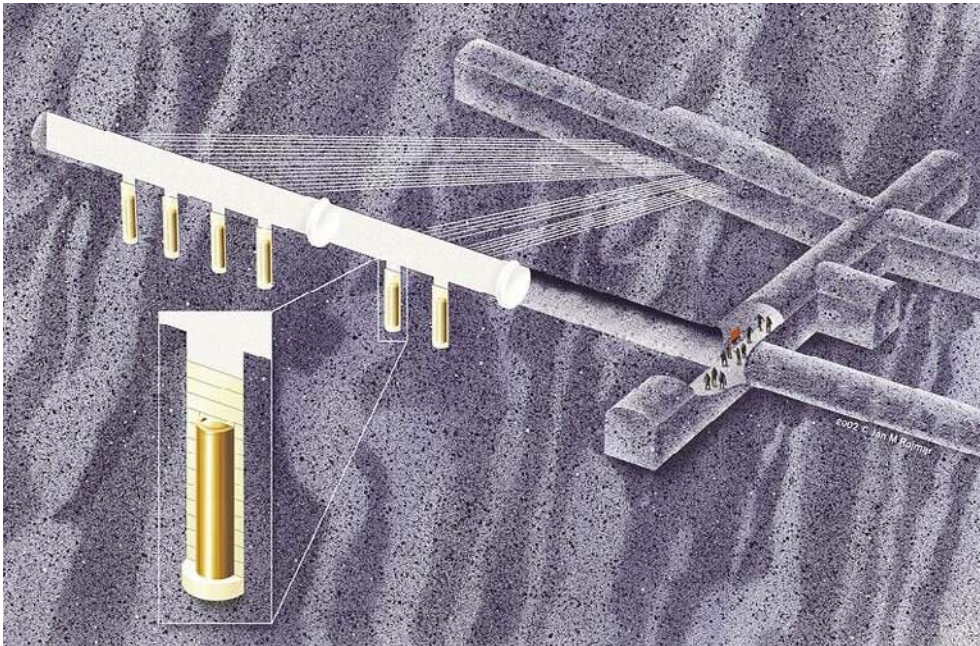

The Prototype Repository is located in the TBM-tunnel at the -450 m level and includes six full scale deposition holes. The aims of the Prototype Repository are to demonstrate the integrated function of the repository components and to provide a full-scale reference for comparison with models and assumptions.

The Prototype Repository should, to the extent possible, simulate the real repository system regarding geometry, materials and rock environment.

Instrumentation is used to monitor processes and properties in the canister, buffer material, backfill and the near-field rock. The evolution will be followed for a long time.

The inner tunnel (Section I) was installed and the plug cast in 2001 and the heaters in the canisters were turned on one by one. The outer tunnel (Section II) was backfilled in June 2003 and the tunnel plug with two lead-throughs was casted in September the same year.

---

### **Achievements**

The data collection system comprises temperature, total pressure, pore water pressure, relative humidity and resistivity measurements in buffer and backfill, as well as temperature and water pressure measurements in boreholes in the rock around the tunnel. The collection of data is in progress and the work with data report No. 14 covering the period up to December 2005 is ongoing. Overhauling of the data acquisition system is in progress and hydraulic tests of the rock mass have been done.

Hydraulic tests (Test campaign 6) of the rock around the Prototype Repository have been performed. The objective of the tests is to estimate the transmissivity of the rock.

A program for sampling and analyses of gases and microorganisms in the backfill and buffer has started and the first campaign has been finalised. This work has been reported in a technical document. Later, when more campaigns have been completed, the work will be published in an International Progress Report (IPR).

A thermal FEM model for the Prototype Repository including the rock, backfill, buffer and the six canisters has been developed and the reporting of the work is ongoing. Furthermore the THM-modelling of the buffer in deposition hole 1 has been initiated.

## 5.2 Long Term Test of Buffer Material

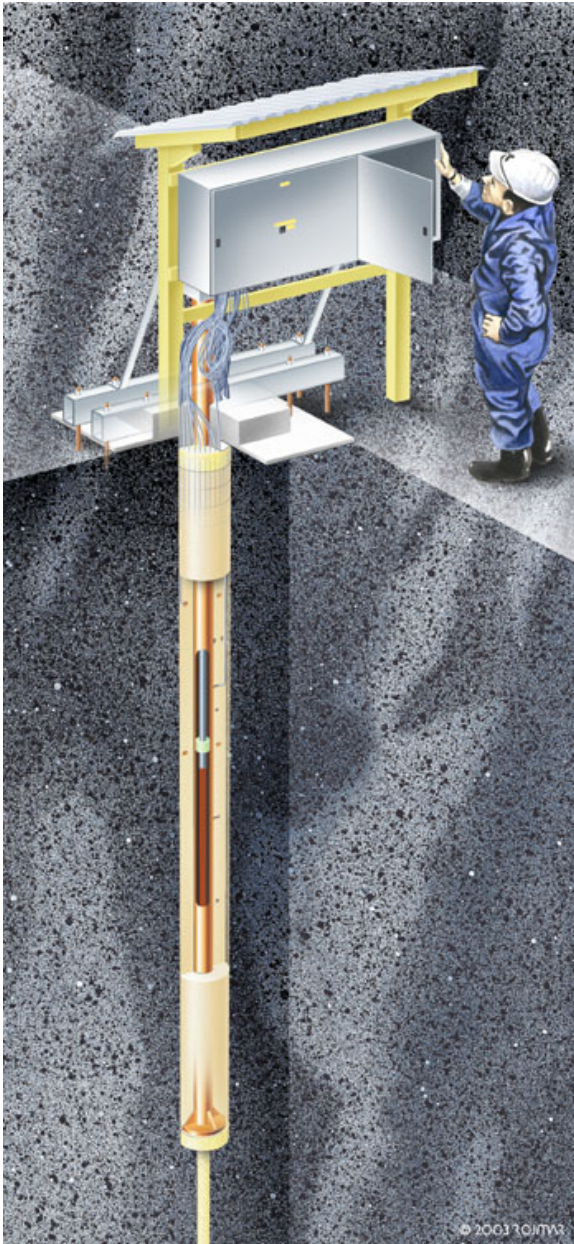

The Long Term Test of Buffer Material aims to validate models and hypotheses concerning mineralogy and physical properties in a bentonite buffer.

The test parcels containing heater, central tube, clay buffer, instruments and parameter controlling equipment are placed in boreholes with a diameter of 300 mm and a depth of around 4 m.

Temperature, total pressure, water pressure and water content, are measured during the heating period. At termination of the tests, the parcels are extracted by overlapping core-drilling outside the original borehole. The water distribution in the clay is determined and subsequent well-defined mineralogical analyses and physical testing of the buffer material are made.

The test parcels are also used to study related processes such as bentonite diffusion properties, microbiology, copper corrosion and gas transport in buffer material under conditions similar to those expected in a deep repository.

### **Achievements**

Parcel A2 has been retrieved successfully. The first general analyses show that the bentonite buffer was fully water saturated and that all material can be used for the analyses. Test material has been distributed to laboratories in Sweden, Finland, Switzerland, Germany and France. The main efforts concern chemical/mineralogical alteration of the buffer material, but minor studies will also be made on cation diffusion, bacterial activity/survival and copper corrosion. All tests have been started and some preliminary results have been achieved. The most interesting results so far concerns copper corrosion, which was significant in the one year tests parcels (A0, A1 and S1) due to the oxidising initial conditions. The results from the present five year test show that the total corrosion is very similar to that in the one year tests, indicating that the corrosion has ceased after the initial consumption of oxygen.

**Table 5-1 Test series for the Long Term Test of Buffer Material.**

Type	No.	max T (°C)	Controlled parameter	Time (years)	Remark
A	1	130	T, [K <sup>+</sup> ], pH, am	1	Reported
A	0	120-150	T, [K <sup>+</sup> ], pH, am	1	Analysed
A	2	120-150	T, [K <sup>+</sup> ], pH, am	5	Terminated (uptake January 2006)
A	3	120-150	T	5	On-going
S	1	90	T	1	Reported
S	2	90	T	5	On-going
S	3	90	T	>>5	On-going

A = adverse conditions

S = standard conditions

[K<sup>+</sup>] = potassium concentration

T = temperature

pH = high pH from cement

am = accessory minerals added



## 5.3 Backfill and Plug Test

---

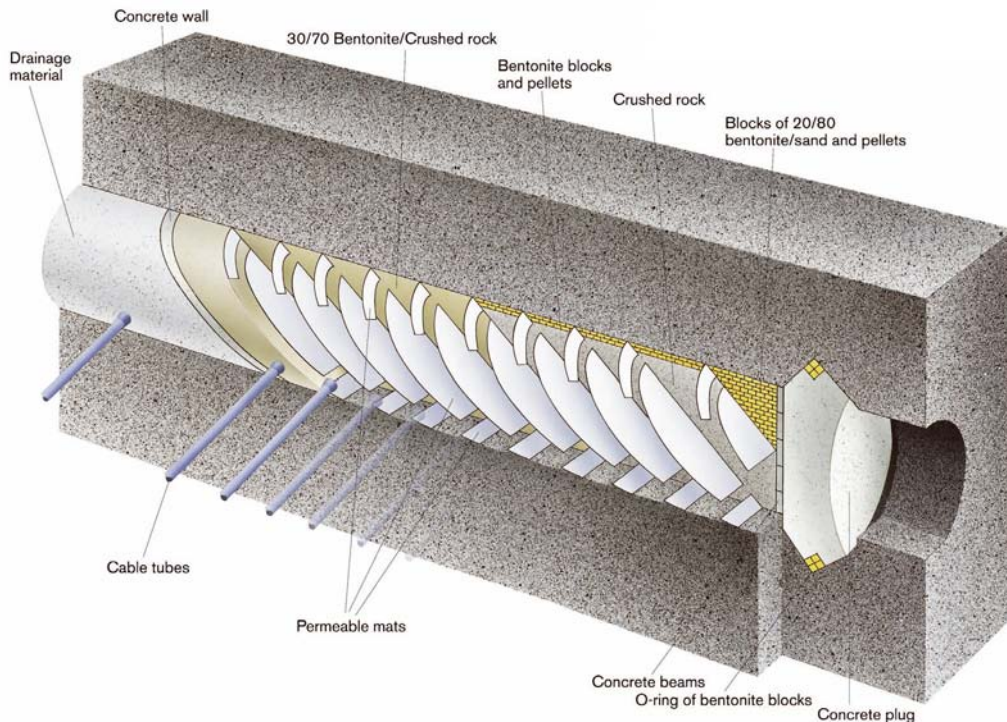

The Backfill and Plug Test includes tests of backfill materials, emplacement methods and a full-scale plug. The inner part of the tunnel is filled with a mixture of bentonite and crushed rock (30/70) and the outer part is filled with crushed rock and bentonite blocks and pellets at the roof.

The integrated function of the backfill material and the near-field rock in a deposition tunnel excavated by blasting is studied as well as the hydraulic and mechanical functions of the full-scale concrete plug.

The entire test set-up with backfill, instrumentation and casting of the plug was finished in the end of September 1999 and the wetting of the 30/70 mixture through filter mats started in late 1999.

The backfill was completely water saturated in 2003 and flow testing for measurement of the hydraulic conductivity has been running since late 2003.

---

### **Achievements**

Water saturation, water pressure and swelling pressure in the backfill as well as water pressure in the surrounding rock have been continuously measured and registered.

Flow testing of the backfill materials between the mats has been finalised in two directions. Additional flow testing in individual points is running and so far the results support those from the flow tests between the mats.

In addition to the field testing, laboratory experiment and modelling with the aim to evaluate the hydraulic conductivity of the backfill materials are in progress but are delayed.

## 5.4 Canister Retrieval Test

---

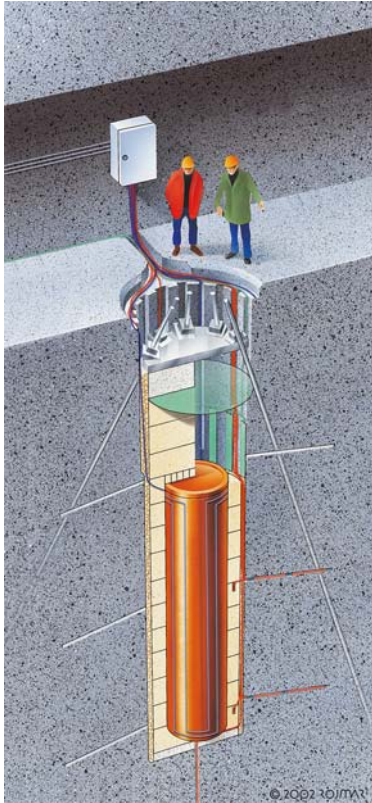

The Canister Retrieval Test is aiming at demonstrating the readiness for recovering of emplaced canisters also after the time when the bentonite is fully saturated.

In the Canister Retrieval Test two full-scale deposition holes have been drilled, at the -420 m level, for the purpose of testing technology for retrieval of canisters after the buffer has become saturated.

These holes have been used for studies of the drilling process and the rock mechanical consequences of drilling the holes.

Canister and bentonite blocks were emplaced in one of the holes in 2000 and the hole was sealed with a plug, heater turned on and artificial water supply to saturate the buffer started.

In January 2006 the retrieval phase was initiated. The saturation phase had, at that time, been running for more than five years with continuous measurements of the wetting process, temperature, stresses and strains.

---

### ***Achievements - Saturation phase***

Excavation and sampling of bentonite buffer started in January and has been going on during the first quarter. The measurements with a large number of transducers in order to study the THM-processes and to provide a basis for e.g. modelling purposes have continued during the excavation in order to yield as much information as possible about the effect of the pressure decrease during excavation. Modelling of wetting and homogenisation of the buffer during the saturation process is in progress although delayed.

### ***Achievements - Retrieval phase***

During the first quarter of 2006 the retrieval phase of the project was initiated. So far the buffer has been excavated manually and approximately 1,500 bentonite samples have been taken. The buffer will be analysed in order to investigate for example; density, water content, microbiological activity and copper migration. The analyses will continue in the second and third quarter of 2006. A heater study has also been initiated in order to investigate the cause of the heater failure. So far problems with the power cables have been identified. Further examinations will be conducted to rule out or verify problems with the heater itself.

During the second quarter the disintegration of the remaining bentonite will be conducted as well as the retrieval of the canister. Analyses of the canister and the properties of the surrounding rock in the deposition hole will thereafter be made.

## 5.5 Temperature Buffer Test

---



The French organisation Andra carries out the Temperature Buffer Test (TBT) at Äspö HRL in co-operation with SKB.

The aims of the TBT are to evaluate the benefits of extending the current understanding of the THM behaviour of engineered barriers during the water saturation transient to include high temperatures, above 100°C.

The scientific background to the project relies on results from large-scale field tests on EBS, notably Canister Retrieval Test, Prototype Repository and Febex (Grimsel Test Site).

The test is located in the same test area as the Canister Retrieval Test, which is in the main test area at the -420 m level.

The TBT experiment includes two heaters in the axis of the deposition hole, one on top of the other, separated by a compacted bentonite block. The heaters are 3 m long and 610 mm in diameter and are constructed in carbon steel. Each one simulates a different type of confinement system: a bentonite buffer only (bottom section) and a bentonite buffer with inner sand backfill (upper section).

An artificial water pressure is applied in a slot between the buffer and rock, which is filled with sand and functions as a filter.

---

### **Achievements**

The TBT-test is in the operation and data acquisition phase since March 2003. The collection of data is continuing and data report No. 7 covering the period up to 1<sup>st</sup> of January 2006 is in press /Goudarzi *et al.* 2006/. Data acquisition is continuously ongoing and data is reported on a monthly basis. The data link from Äspö to Andra's head office in Paris has been functioning well.

The artificial watering and evaluations are in progress and the bentonite around the upper heater appears to be close to saturated, whereas the innermost parts of the blocks around the lower heater still are unsaturated. The filter mats between the bentonite cylinders above the upper heater were activated on December 9, 2005.

A new predictive modelling task was recently initiated. This task is similar to the previous one, with simultaneous blind predictive modelling and experimental work conducted by CEA. This test (TBT\_3) follows a simpler and more efficient thermal protocol. The experimental setup has also been improved. A modelling meeting will be held at Äspö HRL at the end of April to discuss modelling results, additional modelling tasks and the future operation of the field test.

## 5.6 KBS-3 Method with Horizontal Emplacement

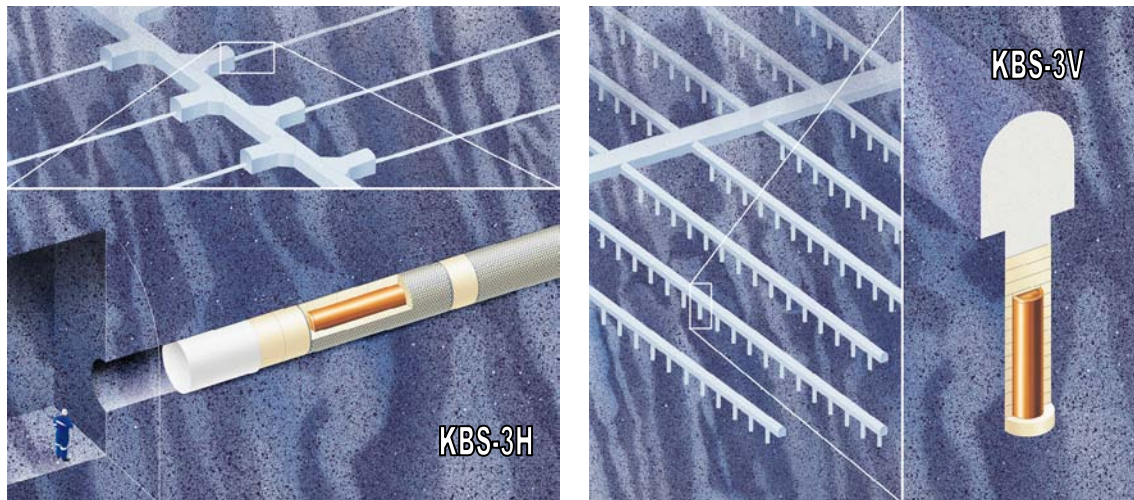

The possibility to modify the reference KBS-3 method and make serial deposition of canisters in long horizontal deposition holes (KBS-3H), instead of deposition of single canisters in vertical deposition holes (KBS-3V), is studied in this project.

One reason for proposing the change is that the deposition tunnels in KBS-3V are not needed if the canisters are disposed in long horizontal deposition holes and the excavated rock volume and the amount of backfill can be considerably reduced. This in turn reduces the environmental impact during the construction of the repository and also the construction costs.

The site for the demonstration of the method is located at -220 m level. A niche with a height of about 8 m and a bottom area of 25 x 15 m forms the work area. Two horizontal deposition holes have been excavated, one short with a length of about 15 m and one long with a length of about 95 m. The deposition equipment will be tested in the long hole and the short hole will be used for testing of a low-pH shotcrete plug and of different drift components.

The KBS-3H project is partly financed by the EC-project Esdred – Engineering studies and demonstration of repository designs.

### **Achievements**

The first quarter of 2006 work has been focused on the following parts:

- Preparation of a niche for the deposition equipment.
- Delivery and transport of the deposition equipment to the – 220 m level.
- Preparation of the deposition equipment for the Site Acceptance Test (SAT).
- Test of low pH shotcrete plug.

The niche at -220 m level has been prepared with data connection and electric supply for the deposition equipment. Docking flange and positions block are measured to meet the tolerances of positioning the transport tube and deposition machine. A steel frame has been installed to lift up the control room in the same level as the deposition equipment. It was also necessary to montage some protection in the roof, to avoid dripping of water on the deposition equipment when it is in position for deposition. Lights have been installed in the ceiling of the niche. The area around the docking flange has been painted. The transport road from the surface down to the niche has been prepared with a guide line and the transport vehicle has been equipped with a position system. A charge-coupled device (CCD) camera and two diffusion lasers are mounted at

the transport truck and are connected to a 7" LCD display in the drivers cab for visual overview. The lasers indicate on different nuances on the transport road and the indicators visualise this in the display.

The component parts of two Super containers - copper canisters, buffer rings and perforated steel cylinders - were delivered and assembled late 2005. The deposition equipment where delivered to Äspö at the 10<sup>th</sup> of March. After unloading the equipment, the transport tube was mounted over one of the two Super containers. After that, the transport tube where lifted out from the assembly hall and the heavy gamma gate was dismantled. The transport of the transport tube with the Super container to -220 m level where performed at 15<sup>th</sup> of March. The transport of the deposition machine to the -220 m level took place two days later, at 17<sup>th</sup> of March. After the delivery the manufacture of the deposition equipment (CNIM) started with the hydraulic and electric connections. The connections and adjustments are planned to be finished until 3<sup>rd</sup> of April, when the Site Acceptance Test is scheduled to start.

The low-pH shotcrete plug was casted in the short hole in the beginning of November 2005. The preparation work for failure test of the plug started at 2<sup>nd</sup> of February. Aitemin did the installation of water injection pipes, extensometers, Acoustic Emission System and testing of the total pressure cells. The plan was to fill the chamber with water and then to have it under 1 MPa pressure during one week in February. After Aitemin had filled the chamber and tried to increase the pressure, they discovered a leakage in the system, which made it impossible to stabilise the pressure with the water pump they used. Aitemin decided to use other pumps with higher capacity. The second attempt to increase the pressure in the chamber started 28<sup>th</sup> of February and the failure test was done 2<sup>nd</sup> of March. Two pressure cycles were performed which resulted in a 12 mm displacement of the plug. The pressure used to get this displacement was 2.76 MPa. The results of the test were discussed at a technical Esdred meeting on 29<sup>th</sup> of March.

## 5.7 Large Scale Gas Injection Test

---

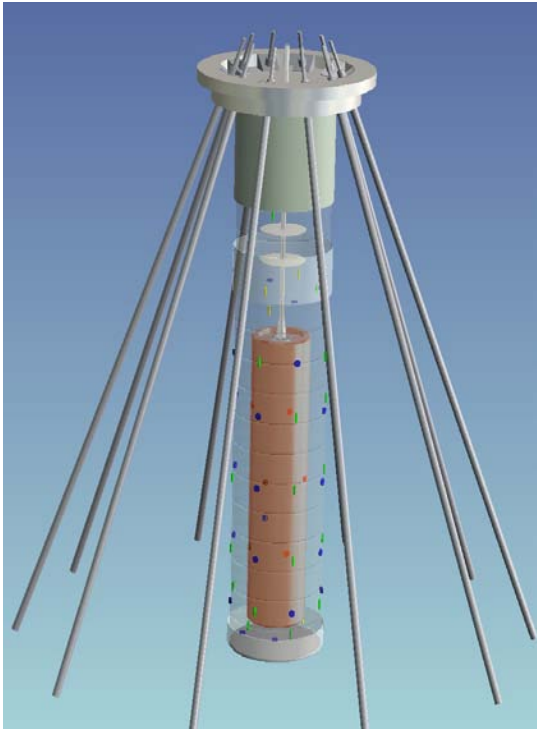

*Layout of the Lasgit experiment conducted in the assembly hall area at the -420 m level.*

Current knowledge pertaining to the movement of gas in a compact buffer bentonite is based on small-scale laboratory studies. These diagnostic tests are designed to address specific issues relating to gas migration and its long-term effect on the hydro-mechanical performance of the buffer clay.

Laboratory studies have been used to develop process models to assess the likely implications of gas flow in a hard-rock repository system. While significant improvements in our understanding of the gas-buffer system have taken place, a number of important uncertainties remain. Central to these is the issue of scale and its effect on the mechanisms and process governing gas flow in compact bentonite.

The question of scale-dependency in both hydration and subsequent gas phases of the test history are central issues in the development and validation of process models aimed at repository performance assessment. To address these issues, a Large Scale Gas Injection Test (Lasgit) has been initiated. Its objectives are to:

- Perform and interpret a large scale gas injection test based on the KBS-3 design concept.
- Examine issues relating to up-scaling and its effect on gas movement and buffer performance.
- Provide information on the process of hydration and gas migration.
- Provide high-quality test data to test/validate modelling approaches.

A full-scale canister (without heaters) and a bentonite buffer are installed in a deposition hole in Äspö HRL. Water is, since January 2005, artificially supplied to the buffer at isothermal conditions. When the buffer is fully saturated gas injection will start, first with small gas volumes and finally with volumes corresponding to gas formation from a defect full-size canister.

---

### **Achievements**

The Lasgit deposition hole was closed on the 1<sup>st</sup> February 2005 signifying the start of the hydration phase. Initial problems with high groundwater inflow rates were addressed by drilling two pressure-relief holes in the surrounding rock mass. Artificial hydration began 106 days later through all of the canister filters and a number of the large hydration mats. During 2005 the resaturation phase of the Lasgit experiment was examined using numerical models developed with the Tough2 code and the EOS3 equation of state module. A series of model runs were performed examining the sensitivity of the system to a number of factors including the role of hydraulic fractures intersecting the deposition hole and the importance of the permeability of the zone adjacent to the canister.

Monitored values of axial and radial stress have progressively increased since closure of the deposition hole. Radial stress measured on the canister surface is comparable with the average value of radial stress monitored on the rock face. Analysis of the volumetric flow rate data indicates a higher permeability zone in the region of the system around the canister. Sensors monitoring canister position clearly show that movements of the canister are sensitive to changes in porewater pressure.

## 5.8 In Situ Corrosion Testing of Miniature Canisters

---

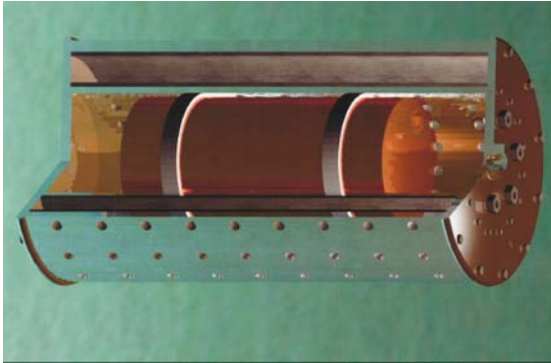

*Miniature canister with support cage*



*Borehole drilling*

This project (MinCan) is designed to provide information about how the environment inside a copper canister containing a cast iron insert would evolve if failure of the outer copper shell were to occur. The development of the subsequent corrosion in the gap between the copper shell and the cast iron insert would affect the rate of radionuclide release from the canister. The information obtained from the experiments will be valuable in providing a better understanding of the corrosion processes inside a failed canister.

Miniature canisters with a diameter of 14.5 cm and containing 1 mm diameter defects in the outer copper shell are being set up in five boreholes with a diameter of 30 cm and a length of 5 m at the Äspö HRL. The canisters will be mounted in support cages, which will contain bentonite clay, and will be exposed to natural reducing groundwater. Together with corrosion test coupons which will also be in the boreholes, the canisters will be monitored for several years. The corrosion will take place under realistic oxygen-free repository conditions that are very difficult to reproduce and maintain for long periods of time in the laboratory.

---

### ***Achievements***

The MiniCan experiment was initiated in 2005, when five boreholes (76 mm diameter) were drilled in a niche at tunnel length 3,384 m (NASA) and the components and support cages of the canister experiments were designed. Five miniature canisters and the first support cage have been fabricated. The other four support cages will be fabricated after the first experiment has been assembled and tested.

Some problems have been experienced with excess water emerging from the rock faces around the boreholes. Therefore, the rock volume where the boreholes are drilled will be grouted to a depth of 1 m in order to get a higher groundwater pressure in the boreholes. The experiment will be installed and initiated during 2006. The remaining activities will comprise reaming of the last part of the boreholes to 302 mm, followed by emplacement of the support cages containing the miniature canisters and installation of the monitoring instrumentation. The first phase of the experiment is planned to run for five years.

## 5.9 Cleaning and Sealing of Investigation Boreholes

---

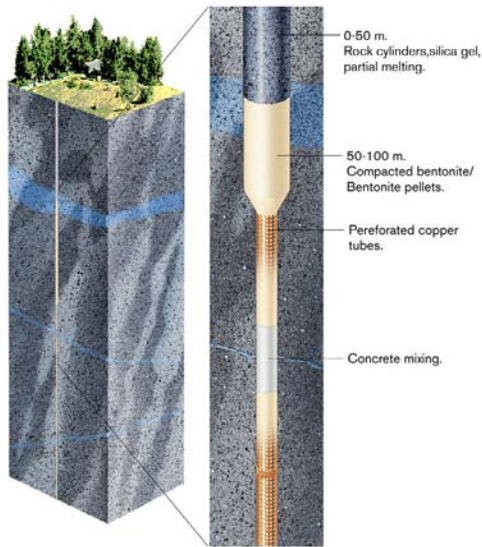

A project, with the aim to identify and demonstrate the best available techniques for cleaning and sealing of investigation boreholes, was initiated in 2002.

The project comprise three phases. Phase 1 was mainly an inventory of available techniques, and the aim of Phase 2 was to develop a complete cleaning and sealing concept. Phase 3 comprise large-scale testing of the sealing concept in boreholes.

A laboratory test program on candidate sealing materials is part of the project. Short and long boreholes from the surface and from tunnels underground, will be used to demonstrate the plugging concept.

The project is run in co-operation between SKB and Posiva.

---

### Achievements

The third phase of the project has been initiated and the status of the on-going project is given below:

*Sub-project 1* – comprises the engineering of design solutions of borehole plugs of clay and cement. Chemical studies of the quartz/cement mixing for the plug has been done by the Swedish cement and concrete research institute and samples have also been sent to Germany. Results from the studies will be delivered during April. Equipment for erosion test by using a backpressure on the copper/bentonite plug, in order to simulate the increasing hydraulic head during the installation in the hole have been ordered and testing will start during April. Improvement and manufacturing of “bentonite container” for placing clay plugs in deep holes without perforated copper tubes have started. Same techniques and equipments could be used for placement of cement/quartz plugs in the boreholes.

*Sub-project 2* – comprise plugging and testing of eight 5 m deep, 76-80 mm diameter boreholes at Äspö HRL. The aim is to test simpler sealing techniques that can be applied in shorter boreholes, especially in holes drilled from a repository. Hydraulic characterisation of the boreholes was finished during March. A programme for plugging and testing the holes, together with prediction of maturation of the bentonite, has been presented. A proposal for two new short boreholes for investigation of physical and chemical interaction of quartz/cement and clay plugs is in the first draft version. The boreholes could act as a complement to the test in the borehole at Onkalo in Finland (OL-KR24).



*Sub-project 3* – comprises preparation, stabilisation and installation of plugs in the 76 mm wide borehole OL-KR24 at Onkalo. The field work in the borehole was finished in December 2005. Information from the work will be compiled in a report together with predictions of the maturation of the bentonite. A symposium is planned for early May in Finland.

*Sub-project 4* – has the aim to test the feasibility of candidate techniques intended for mechanical securing of the tight seals emplaced lower in deep boreholes. Designing of equipment for enlarging boreholes (194-300 mm), in order to construct a mechanical blocking in the upper part of the boreholes is on-going. Percussion drilling of two 200 mm wide boreholes at the surface for testing the enlarging equipment is in progress.

## **5.10 Alternative Buffer Materials**

In the Alternative Buffer Materials project different types of conceivable buffer materials will be tested in field scale. The aim is to further investigate the properties of the alternatives to the SKB reference MX-80 material.

The project will be carried out using material that according to laboratory studies are conceivable buffer materials. The experiment will be carried out in the same way and scale as the Long Term Test of Buffer Material (see Section 5.2).

The objectives are to:

- Verify results from laboratory studies during more realistic conditions with respect to temperature, scale and geochemical circumstances.
- Discover possible problems with manufacturing and storage of bentonite blocks.
- Give further data for verification of thermo-hydro-mechanical (THM) and geochemical models.

### ***Achievements***

Excavation of the experiment site has begun. The experiment will be located in the TASQ tunnel at the -450 meter level in Äspö HRL.

Buffer materials have been purchased and block pressing will commence in the second quarter of 2006. The international project members are preparing the materials they wish to test.

## 5.11 Rock Shear Experiment

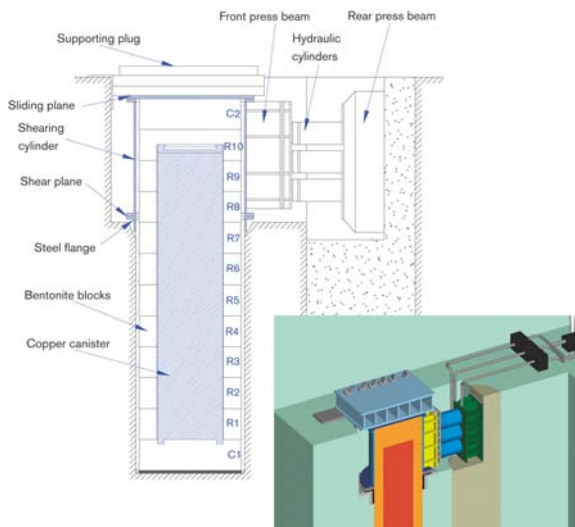

The Rock Shear Experiment (Rose) aims at observing the forces that act on a KBS-3 canister if a displacement of 100 mm would take place in a horizontal fracture that crosses a deposition hole. Such a displacement may be caused by an earthquake, and the test set-up need to provide a shearing motion along the fracture that is equal to the worst expected shearing motion in real life.

The *in situ* test set-up is planned to be installed at the Äspö Pillar Stability site. Two full scale deposition holes already exist with a rock pillar of one metre in between. One deposition hole will be used for the buffer and canister, while the other deposition hole is used for the shearing equipment.

### Achievements

A pre-study of design and feasibility is completed and reported. The main conclusion is that the test is feasible. A preliminary decision to realize the plans has been taken but the time schedule is not yet set. No work has been done in 2006 so far.

## 5.12 Earth Potentials

The main objective of the project is to identify the magnitude of potential fluctuations and stray currents at repository depth. The causes to these effects may be Geomagnetically Induced Currents (GIC) or man-made stray current sources. The aim is also to find out the problems these effects could cause in a deep repository. The project will include the following investigations:

- Electromagnetic induced currents from natural sources.
- Electrochemical reactions in soil and rock.
- The transition from ion transfer in bentonite to electron transport in copper.
- Impact of copper ions on bentonite properties.
- Physical and chemical interactions between copper and bentonite.
- Basic processes in clay that are exposed to direct current (DC).
- Microbes as electron transmitters.

### Achievements

The laboratory experiments, performed at Clay Technology in Lund, on the impact of copper ions on bentonite properties are almost finished. Some complementary studies are going to be done and a draft report will be presented at a meeting in June.

A new setup for testing of electric behaviours between copper and bentonite has been developed at the Corrosion Institute in Stockholm. Some results will be presented at a meeting in June.

Measurements of natural electromagnetic fields (magnetotelluric technique), by Uppsala University, have been finished and a report is in progress.

A project meeting was held in Stockholm early February where the status of the project was discussed.

### **5.13 Task Force on Engineered Barrier Systems**

The Task Force on Engineered Barrier Systems (EBS) is a natural continuation of the modelling work in the Prototype Repository Project, where also modelling work on other experiments, both field and laboratory tests, are conducted. The Äspö HRL International Joint Committee has decided that in the first phase of this Task Force (period 2004-2008), work should concentrate on:

Task 1 THM modelling of processes during water transfer in buffer, backfill and near-field rock. Only crystalline rock is considered initially, although other rock types could be incorporated later.

Task 2 Gas transport in saturated buffer.

The objectives of the Tasks are to: (a) verify the capability to model THM and gas migration processes in unsaturated as well as saturated bentonite buffer, (b) refine codes that provide more accurate predictions in relation to the experimental data and (c) develop the codes to 3D standard (long-term objective).

Beside SKB seven international organisations are participating in the Task Force. These organisations are funding 13 modelling teams.

#### ***Achievements***

For Task 1 (THM-processes) two benchmarks have been presented, each with two laboratory tests:

- Benchmark 1.1 - THM mock-up experiments on compacted MX-80 bentonite, with two different initial water contents. The experiments have been performed by CEA.
- Benchmark 1.2 - Large-cell experiments are currently being performed by Ciemat in their laboratory in Madrid. One of the tests is kept under isothermal conditions and the other test is performed under a thermal gradient.

Results of the two benchmark tests for Task 1 were submitted from eight of the modelling teams. The results are compiled and audited during this period.

For Task 2 (gas) two benchmark tests were presented at the last meeting. The modelling teams working with these benchmarks will show their results at the next meeting, which will be held in Äspö HRL 25<sup>th</sup>-26<sup>th</sup> April.

## 6 Äspö facility

Important parts of the Äspö facility are the administration, operation, and maintenance of instruments as well as development of investigation methods. The Public Relations and Visitor Services group is responsible for presenting information about SKB and its facilities e.g. the Äspö HRL. They arrange visits to the facilities all year around as well as special events.

### 6.1 Facility Operation

---

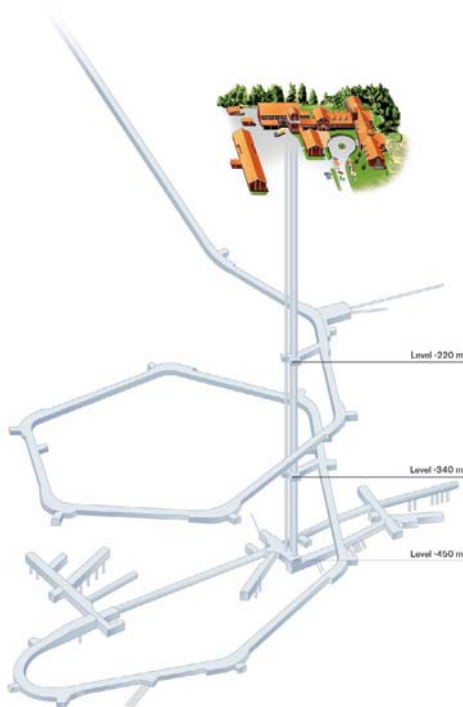

The main goal for the operation of the facility is to provide a safe and environmentally correct facility for everybody working or visiting the Äspö HRL.

This includes preventative and remedy maintenance in order to withhold high availability in all systems as drainage, electrical power, ventilation, alarm and communications.

---

#### **Achievements**

The facility's safety is good, all the operating systems are functioning well. Improvements are being carried out in order to increase operative safety and also to save electricity. Personnel safety has been increased by the introduction of new rules and instructions.

A remote system for the registration of personnel and other objects in the below-ground facility has been developed and will begin operation during 2006.

A pre-study for the construction of a reserve power system at the facility has been completed. The work to extend one of the reserve power systems is initiated.

Preparations are underway for the building of a laboratory for the testing of bentonite materials.

## 6.2 Public Relations and Visitors Service

---



SKB operates three facilities in the Oskarshamn municipality: Äspö HRL, Central interim storage facility for spent nuclear fuel (Clab) and Canister Laboratory. In 2002 SKB began site investigations at Oskarshamn and Östhammar.

The main goal for the information and public relations group at Äspö HRL, is to in co-operation with other departments at SKB, present information about SKB and its activities and facilities.

---

### ***Achievements***

During the first three months 2006, SKB facilities have been visited by 4 884 persons. Compared with the same period last year this means an increase with 563 persons (+13%). The number of visitors to SKB's main facilities are listed in Table 6-1.

**Table 6-1 Number of visitors to SKB facilities.**

<b>SKB facility</b>	<b>Number of visitors January - March 2006</b>
Central interim storage facility for spent nuclear fuel	397
Canister Laboratory	897
Äspö HRL	1,607
Final repository for radioactive operational waste (SFR)	1,917

## 7 Environmental research

### 7.1 Äspö Research School

Kalmar University's Research School in Environmental Science at Äspö HRL, called Äspö Research School, started in October, 2002. This School is the result of an agreement between SKB and Kalmar University. It combines two important regional resources, i.e. Äspö HRL and Kalmar University's Environmental Science Section. The activity within the School will lead to: (a) development of new scientific knowledge, (b) increase of geo- and environmental-scientific competence in the region and (c) utilisation of the Äspö HRL for environmental research. Currently the scientific team consists of a professor of Environmental geology (Dr. Mats Åström), a research assistant, four assistant supervisors and five Ph.D. students. The research activities focus on biogeochemical systems, in particular in the identification and quantification of dispersion and transport mechanisms of contaminants (mainly metals) in and between soils, sediments, water, biota and upper crystalline bedrock. In addition to financial support from SKB and the University of Kalmar, the school receives funding from the city of Oskarshamn.

#### ***Achievements***

During the year the second Ph. D dissertation is planned to take place.

## 8 International co-operation

Nine organisations from eight countries participate in the Äspö HRL co-operation during 2006, see Table 8-1. Six of them; Andra, BMWi, CRIEPI, JAEA, OPG and Posiva together with SKB form the Äspö International Joint Committee (IJC), which is responsible for the co-ordination of the experimental work arising from the international participation.

Several of the participating organisations take part in the two Äspö Task Forces on: (a) Modelling of Groundwater Flow and Transport of Solutes, which is a forum for co-operation in the area of conceptual and numerical modelling of groundwater flow and solute transport in fractured rock and (b) THMC modelling of Engineered Barrier Systems, which is a forum for code development on THMC processes taking place in a bentonite buffer and at gas migration through a buffer.

**Table 8-1 International participation in the Äspö HRL projects during 2006.**

<b>Projects in the Äspö HRL during 2006</b>	<b>Andra</b>	<b>BMWi</b>	<b>CRIEPI</b>	<b>JAEA</b>	<b>OPG</b>	<b>Posiva</b>	<b>Enresa</b>	<b>Nagra</b>	<b>RAWRA</b>
<b>Geo-science</b>									
Äspö Pillar Stability Experiment					X	X			
<b>Natural barriers</b>									
Tracer Retention Understanding Experiments	X			X		X			
Long Term Diffusion Experiment					X				
Colloid Project		X				X			
Microbe Project		X							
Radionuclide Retention Project		X							
Task Force on Modelling of Groundwater Flow and Transport of Solutes	X	X	X	X	X	X			
<b>Engineered barriers</b>									
Prototype Repository	X	X		X		X			
Long Term Test of Buffer Material						X			
Temperature Buffer Test	X	X					X		
KBS-3 Method with Horizontal Emplacement						X			
Large Scale Gas Injection Test	X	X			X	X			
Task Force on Engineered Barrier Systems	X	X	X		X	X		X	X

### **Participating organisations:**

Agence nationale pour la gestion des déchets radioactifs, Andra, France

Bundesministerium für Wirtschaft und Technologie, BMWi, Germany

Central Research Institute of the Electronic Power Industry, CRIEPI, Japan

Japan Atomic Energy Agency, JAEA, Japan

Ontario Power Generation Inc., OPG, Canada

Posiva Oy, Finland

Empresa Nacional de Residuos Radiactivos, Enresa, Spain

Nationale Genossenschaft für die Lagerung Radioaktiver Abfälle, Nagra, Switzerland

Radioactive Waste Repository Authority, Rawra, Czech Republic

## 9 Documentation

During the period January to March 2006, the following reports have been published and distributed.

### 9.1 Äspö International Progress Reports

**Forsmark T, Rhén I, 2005.** Prototype Repository. Hydraulic tests and deformation measurements during operation phase. Test campaign 5. Interference tests. IPR-05-18, Svensk Kärnbränslehantering AB.

**Goudarzi R, Börgesson L, Röshoff K, Edelman M, 2005.** Canister Retrieval Test. Sensors data report (Period 001026-051101) Report No:11. IPR-05-35, Svensk Kärnbränslehantering AB.

**Goudarzi R, Åkesson M, Hökmark H, 2006.** Temperature Buffer Test. Sensors data report (Period: 030326-060101) Report No:7. IPR-06-04, Svensk Kärnbränslehantering AB.

**Holmen J, Forsman J, 2004.** Äspö Task Force. Modelling of Task 6A and 6B2. IPR-04-39, Svensk Kärnbränslehantering AB.

**Jacobsson L, Bäckström A, 2005.** Unaxial compression tests of intact rock specimens at dry condition and at saturation by three different liquids: distilled, saline and formation water. IPR-05-33, Svensk Kärnbränslehantering AB.

**Pedersen K, 2005.** MICROBE. Analysis of microorganisms and gases in MICROBE groundwater over time during MINICAN drainage of the MICROBE water conducting zone. IPR-05-29, Svensk Kärnbränslehantering AB.

**Pusch R, Börgesson L, Svemar C, 2004.** Prototype Repository. Final report (Deliverable D36). IPR-04-27, Svensk Kärnbränslehantering AB.

**Pusch R, Ramqvist G, 2004.** Borehole sealing, preparative steps, design and function of plugs-basic concept. IPR-04-57, Svensk Kärnbränslehantering AB.

**Savukoski M, 2005.** DECOVALEX. Drill hole KF0066A01 and KF0069A01. Determination of porosity by water saturation and density by buoyancy technique. IPR 05-32, Svensk Kärnbränslehantering AB.

**SKB, 2005a.** Äspö Hard Rock Laboratory. Status Report. July - September 2005. IPR 05-34, Svensk Kärnbränslehantering AB.

**SKB, 2005b.** Äspö Hard Rock Laboratory. Status Report. October - December 2005. IPR-06-03, Svensk Kärnbränslehantering AB.

**Thorsager P, Börgesson L, Johannesson L-E, Sandén T, 2002.** Canister Retrieval Test. Report on installation. IPR-02-30, Svensk Kärnbränslehantering AB.



## **9.2 Technical Documents and International Technical Documents**

**Tullborg E-L, Larsson S-E, 2005.** Matrix Continuation. Porosity and density measurements on samples from drillcore KA2599G01. TD-05-04, Svensk Kärnbränslehantering AB.

## 10 References

- Black J and Hodgkinson D, 2005.** Review of Task 6C. R-05-23, Svensk Kärnbränslehantering AB
- Byegård J, Johansson H, Andersson P, Hansson K, Winberg A, 1999.** Test plan for the long term diffusion experiment. IPR-99-36, Svensk Kärnbränslehantering AB.
- Goudarzi R, Åkesson M, Hökmark H, 2006.** Temperature Buffer Test. Sensors data report (Period: 030326-060101) Report No:7. IPR-06-04, Svensk Kärnbränslehantering AB.
- Hodgkinson D, Black J, 2005.** Review of Tasks 6A, 6B and 6B2. TR-05-14, Svensk Kärnbränslehantering AB.
- Itasca Consulting Group, Inc., 2003.** 3DEC – 3 dimensional distinct element code. User's manual. Itasca, Minneapolis.
- Magnor B, 2004.** Äspö Hard Rock Laboratory. Äspö Pillar Stability Experiment. Geological mapping of tunnel TASQ. IPR-04-03, Svensk Kärnbränslehantering AB.
- Mas Ivars D, 2004.** Inflow into excavations – A coupled hydro-mechanical three-dimensional numerical study. Licentiate Thesis. KTH, Stockholm, Sweden.
- Mas Ivars D, 2005.** Äspö Pillar Stability Experiment. Hydromechanical data acquisition experiment at the APSE site. IPR-05-21, Svensk Kärnbränslehantering AB
- Nyberg G, Jönsson S, Wass E, 2005.** Äspö Hard Rock Laboratory. Hydro monitoring program. Report for 2004. IPR-05-26, Svensk Kärnbränslehantering AB
- Pedersen K, 2005.** MICROBE. Analysis of microorganisms and gases in MICROBE groundwater over time during MINICAN drainage of the MICROBE water conducting zone. IPR-05-29, Svensk Kärnbränslehantering AB.
- SKB, 2004.** RD&D-Programme 2004. Programme for research, development and demonstration of methods for the management and disposal of nuclear waste. TR-04-21, Svensk Kärnbränslehantering AB.
- SKB, 2006.** Äspö Hard Rock Laboratory. Planning Report for 2006. IPR-06-06, Svensk Kärnbränslehantering AB.
- Smellie J, Waberg N, Frape S, 2003.** Matrix fluid chemistry experiment. Final report. June 1998-March 2003. TR-03-18, Svensk Kärnbränslehantering AB.
- Tullborg E-L, Larson S Å, 2006.** Porosity in crystalline rocks – A matter of scale. Eng. Geol., 84, 75-83.